

## GENERAL DESCRIPTION

The SGM2554 is an integrated 95mΩ (TYP) power switch for self-powered and bus-powered Universal Series Bus (USB) applications. A built-in charge pump is used to drive the N-Channel MOSFET that is free of parasitic body diode to eliminate any reversed current flow across the switch when it is powered off. Low quiescent supply current and small package are particularly suitable in battery-powered portable equipment.

Several protection functions include soft-start to limit inrush current during plug-in, current limiting at 1.85A to meet USB power requirement, and thermal shutdown to prevent damage under over current conditions.

The SGM2554 is available in a Green SOT-23-5 package and is rated over the -40°C to +85°C temperature range.

## FEATURES

- **95mΩ (TYP) High-side N-Channel MOSFET**
- **Guaranteed 1.1A Continuous Current**
- **1.85A Current Limit**
- **Input Voltage Range: 2.2V to 5.5V**
- **Low 19μA Supply Current**
- **Less than 1μA in Shutdown Mode**
- **Soft-Start Function**
- **Thermal Shutdown Protection**
- **Under-Voltage Lockout Protection for VIN**
- **No Reversed Leakage Current**
- **Evaluated to IEC 60950-1, Ed 2, Am1, Annex CC, Test Program 1 with CB Report**
- **Available in Green SOT-23-5 Package**

## APPLICATIONS

Motherboard USB Power Switch  
 USB Device Power Switch  
 Hot-Plug Power Supplies  
 Load Switch

## TYPICAL APPLICATION

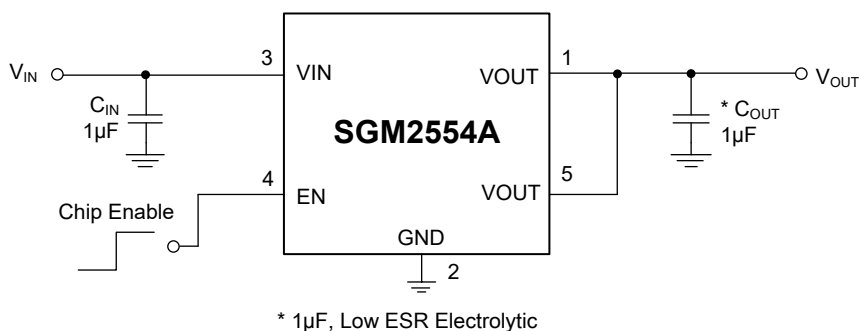

**PACKAGE/ORDERING INFORMATION**

MODEL	PACKAGE DESCRIPTION	SPECIFIED TEMPERATURE RANGE	ORDERING NUMBER	PACKAGE MARKING	PACKING OPTION
SGM2554A	SOT-23-5	-40°C to +85°C	SGM2554AYN5G/TR	SI4XX	Tape and Reel, 3000
SGM2554B	SOT-23-5	-40°C to +85°C	SGM2554BYN5G/TR	SI5XX	Tape and Reel, 3000

**MARKING INFORMATION**

NOTE: XX = Date Code.

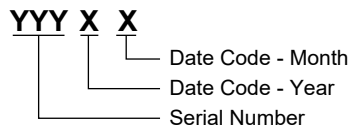

Green (RoHS & HSF): SG Micro Corp defines "Green" to mean Pb-Free (RoHS compatible) and free of halogen substances. If you have additional comments or questions, please contact your SGMICRO representative directly.

**ABSOLUTE MAXIMUM RATINGS**

- Input Supply Voltage..... 6V
- EN Pin..... -0.3V to 6V
- Operating Temperature Range .....-40°C to +85°C
- Package Thermal Resistance
- SOT-23-5,  $\theta_{JA}$  ..... 250°C/W
- Junction Temperature..... +150°C
- Storage Temperature Range .....-65°C to +150°C
- Lead Temperature (Soldering, 10s)..... +260°C
- ESD Susceptibility
- HBM.....2000V
- MM..... 300V

**OVERSTRESS CAUTION**

Stresses beyond those listed in Absolute Maximum Ratings may cause permanent damage to the device. Exposure to absolute maximum rating conditions for extended periods may affect reliability. Functional operation of the device at any conditions beyond those indicated in the Recommended Operating Conditions section is not implied.

**ESD SENSITIVITY CAUTION**

This integrated circuit can be damaged by ESD if you don't pay attention to ESD protection. SGMICRO recommends that all integrated circuits be handled with appropriate precautions. Failure to observe proper handling and installation procedures can cause damage. ESD damage can range from subtle performance degradation to complete device failure. Precision integrated circuits may be more susceptible to damage because very small parametric changes could cause the device not to meet its published specifications.

**DISCLAIMER**

SG Micro Corp reserves the right to make any change in circuit design, or specifications without prior notice.

PIN CONFIGURATIONS

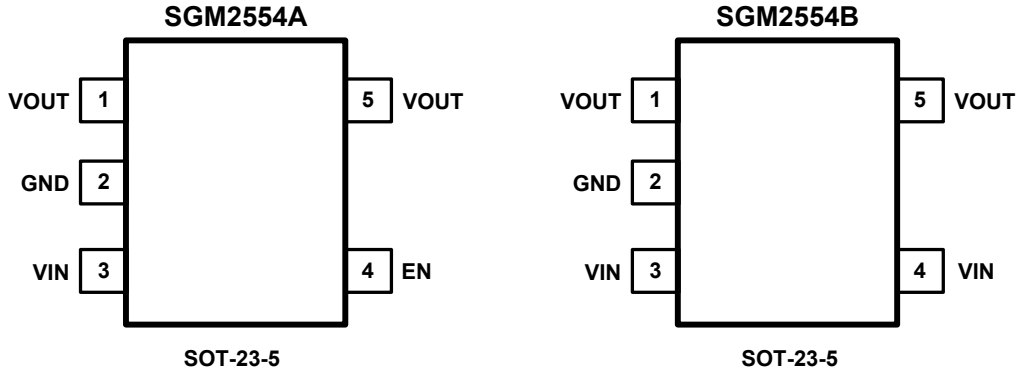

PIN DESCRIPTION

PIN		NAME	FUNCTION
SGM2554A	SGM2554B		
1, 5	1, 5	VOUT	Output Voltage.
2	2	GND	Ground.
3	3, 4	VIN	Power Input Voltage.
4	—	EN	Chip Enable. When EN = "High", chip is enabled.

FUNCTION BLOCK DIAGRAM

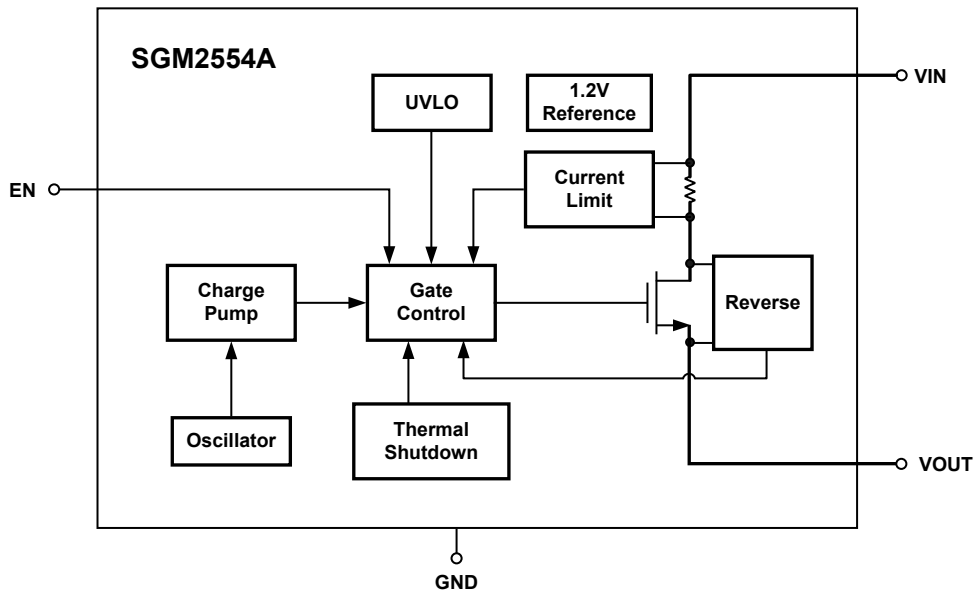

**ELECTRICAL CHARACTERISTICS**(At  $T_A = +25^\circ\text{C}$ ,  $V_{IN} = 5\text{V}$ ,  $C_{IN} = C_{OUT} = 1\mu\text{F}$ , unless otherwise noted.)

PARAMETER		SYMBOL	CONDITIONS	MIN	TYP	MAX	UNITS
Input Voltage Range		$V_{IN}$		2.2		5.5	V
Quiescent Supply Current		$I_Q$	$V_{IN} = 3\text{V}$ , $V_{EN} = 3\text{V}$		18	27	$\mu\text{A}$
			$V_{IN} = 5\text{V}$ , $V_{EN} = 5\text{V}$		19	30	
Shutdown Supply Current	SGM2554A	$I_{SD}$	$V_{EN} = 0\text{V}$		0.1	1	$\mu\text{A}$
Output Leakage Current	SGM2554A	$I_{LEAKAGE}$	$V_{EN} = 0\text{V}$ , $V_{OUT} = 0\text{V}$		0.1	1	$\mu\text{A}$
EN Input Threshold	SGM2554A	$V_{IH}$		1.5			V
		$V_{IL}$				0.4	
Output Turn-On Delay Time		$t_{ON}$	$R_L = 30\Omega$ , $C_{OUT} = 1\mu\text{F}$		1.1		ms
Switch Resistance		$R_{DS(ON)}$	$I_L = 1\text{A}$		95	150	$\text{m}\Omega$
Current Limit Threshold	SGM2554A	$I_{LIM}$	$R_L = 2\Omega$		1.85		A
	SGM2554B		$R_L = 2\Omega$		1.75		
Short-Circuit Output Current	SGM2554A	$I_{SHORT}$	$V_{OUT} = 0\text{V}$ , $V_{IN} = 3\text{V}$		1.2		A
	SGM2554B		$V_{OUT} = 0\text{V}$ , $V_{IN} = 3\text{V}$		1.1		
Under-Voltage Lockout Threshold		$V_{UVLO}$	$V_{IN}$ Rising		1.65		V
Under-Voltage Lockout Threshold Hysteresis					50		mV
Thermal Shutdown Threshold			$T_J$ increasing		125		$^\circ\text{C}$
Thermal Shutdown Hysteresis					20		$^\circ\text{C}$

TEST CIRCUITS

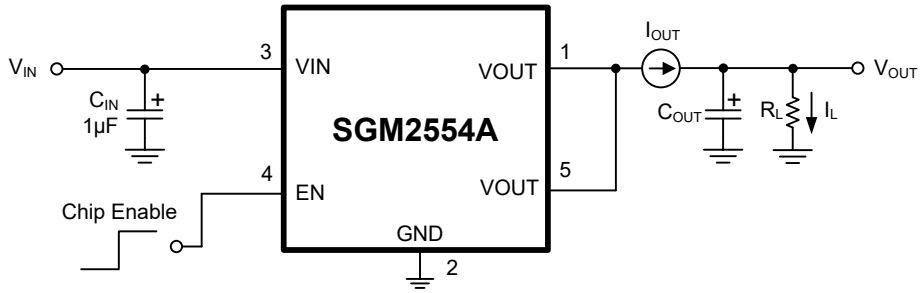

Test Circuit 1

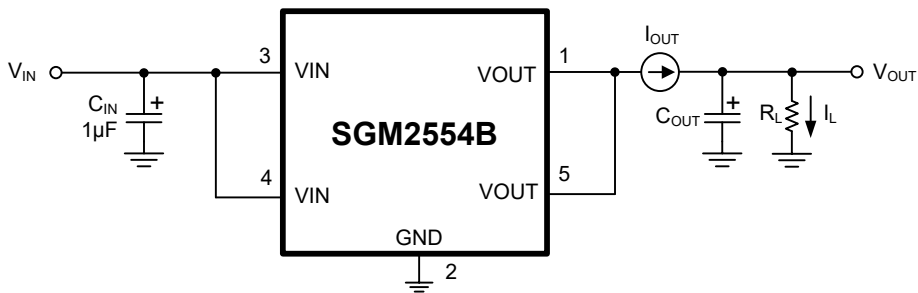

Test Circuit 2

TIMING DIAGRAM

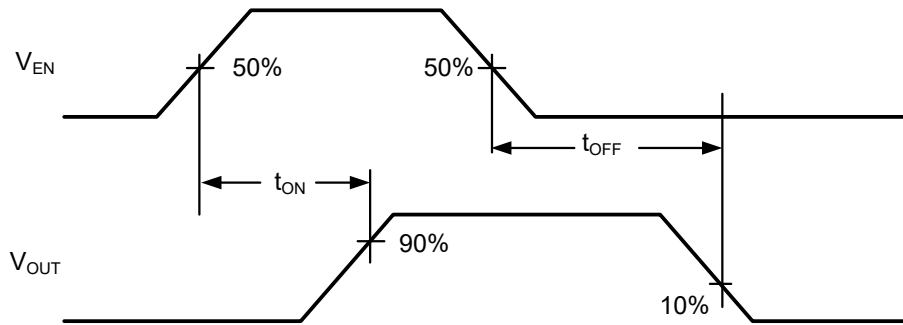

Switch Turn-On or Turn-Off Delay Time

TYPICAL PERFORMANCE CHARACTERISTICS

At  $T_A = +25^\circ\text{C}$ ,  $V_{IN} = V_{EN} = 5\text{V}$ ,  $C_{IN} = C_{OUT} = 1\mu\text{F}$ , unless otherwise noted.

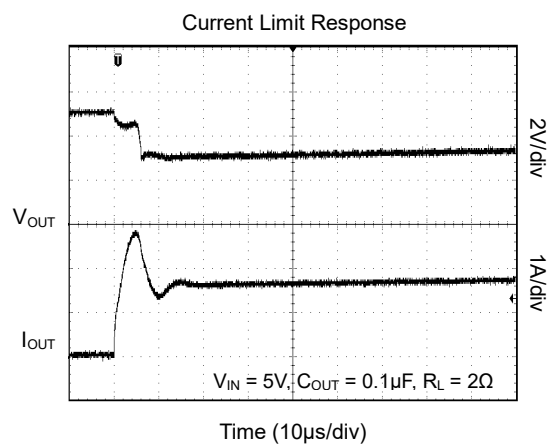
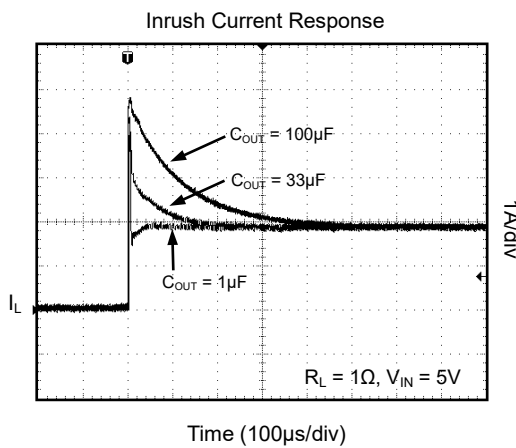
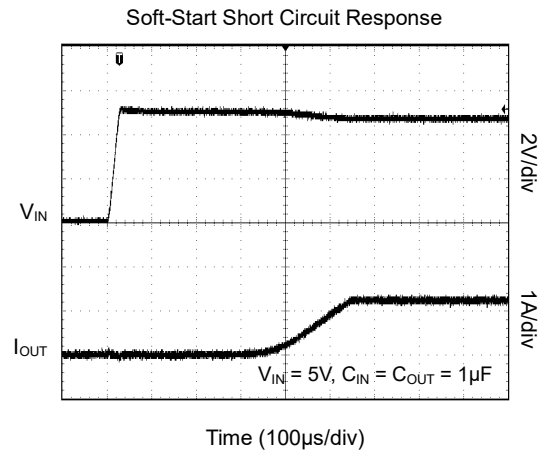
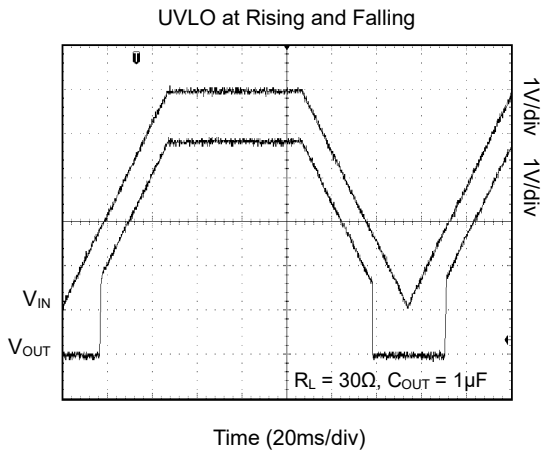
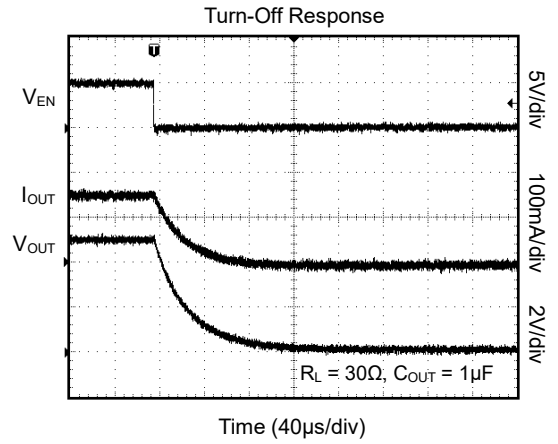
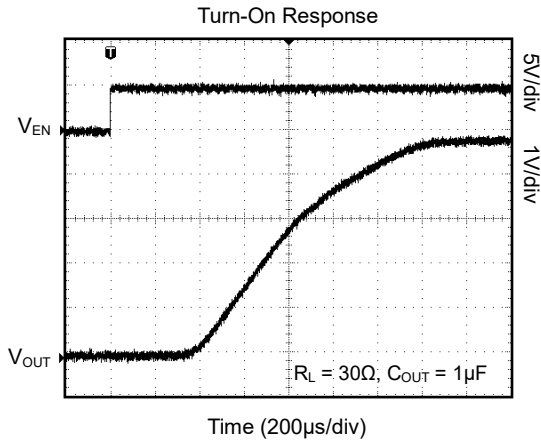

**TYPICAL PERFORMANCE CHARACTERISTICS (continued)**

At  $T_A = +25^\circ\text{C}$ ,  $V_{IN} = V_{EN} = 5\text{V}$ ,  $C_{IN} = C_{OUT} = 1\mu\text{F}$ , unless otherwise noted.

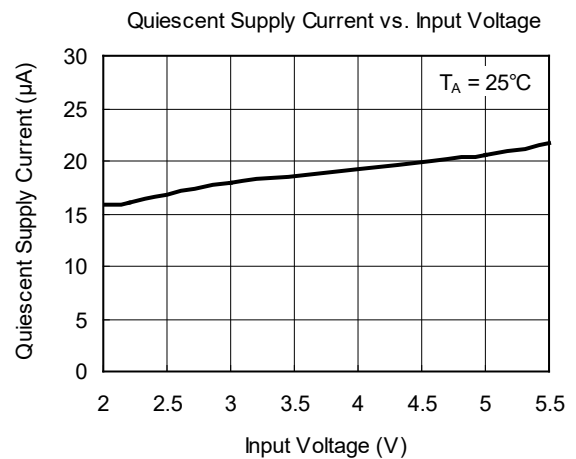
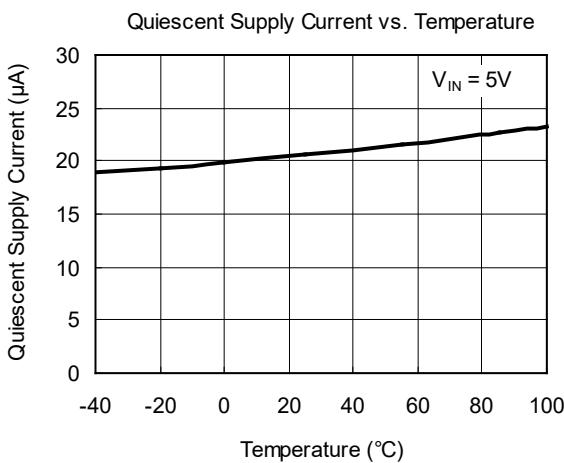
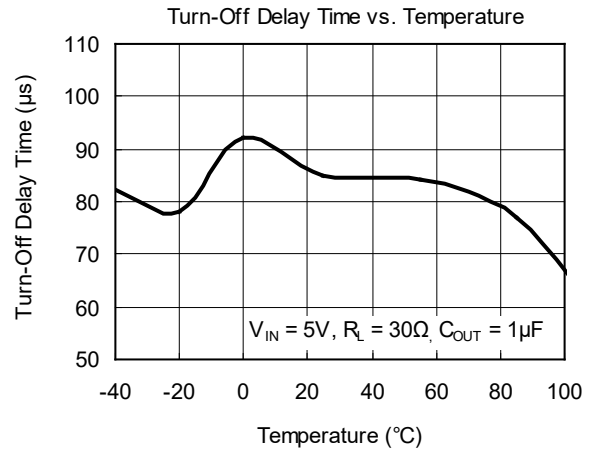
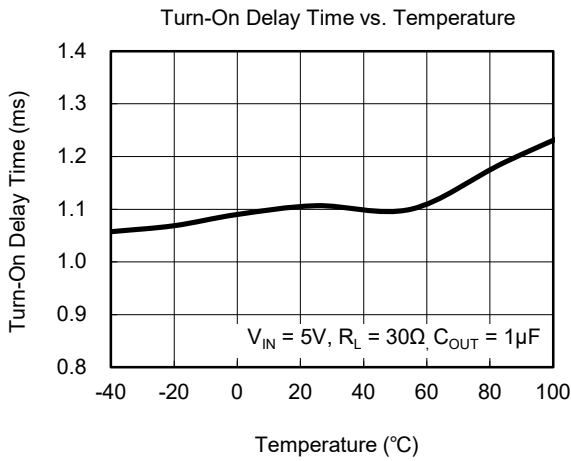
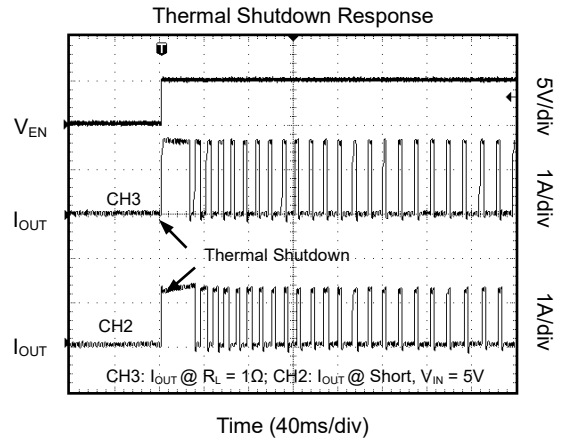
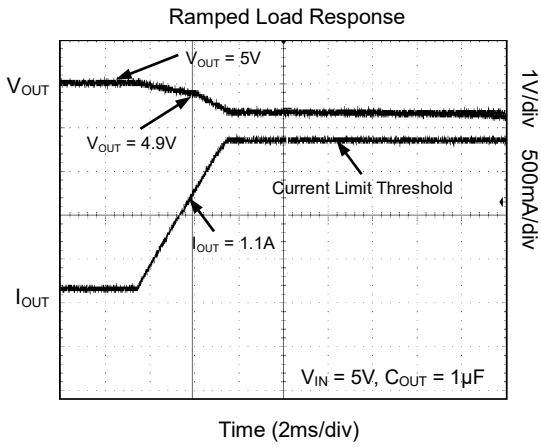

TYPICAL PERFORMANCE CHARACTERISTICS (continued)

At  $T_A = +25^\circ\text{C}$ ,  $V_{IN} = V_{EN} = 5\text{V}$ ,  $C_{IN} = C_{OUT} = 1\mu\text{F}$ , unless otherwise noted.

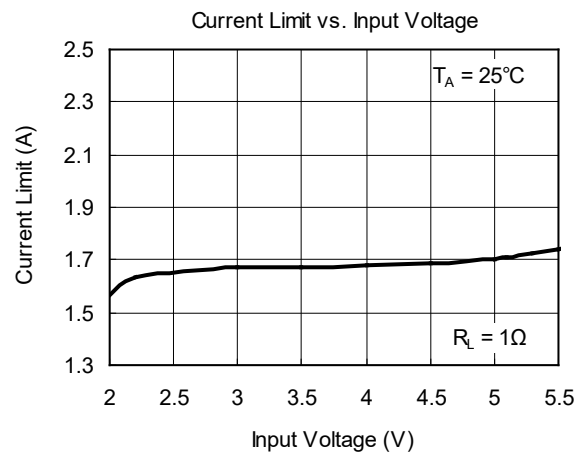
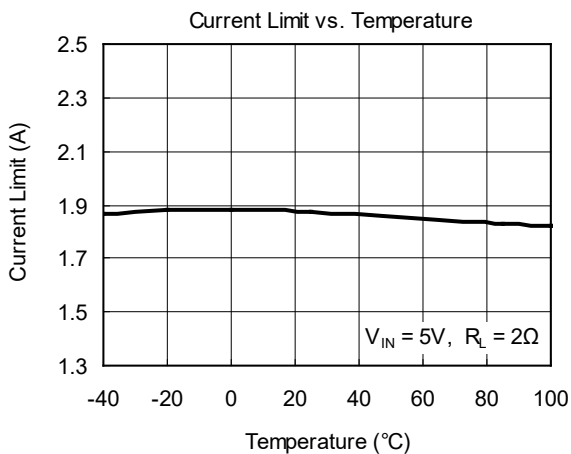
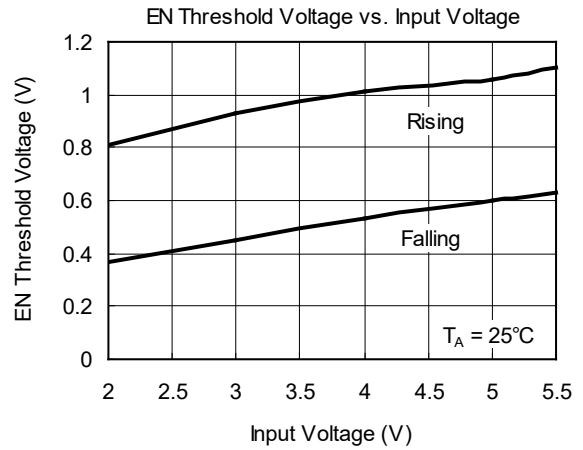
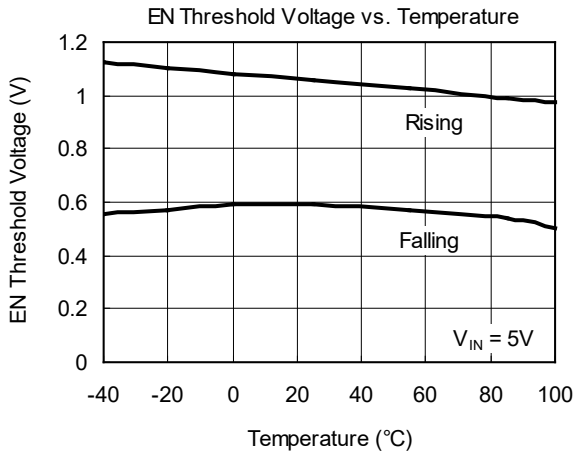
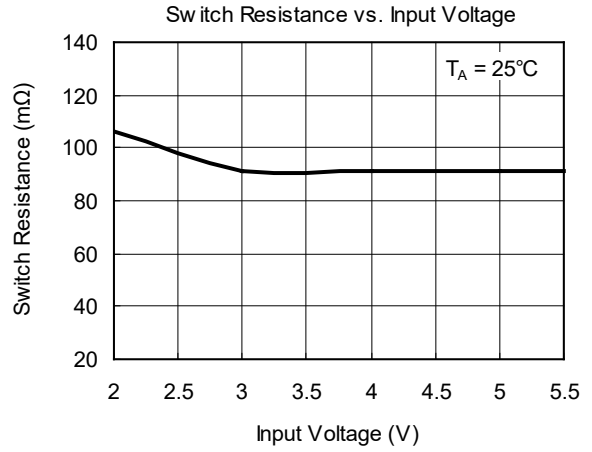
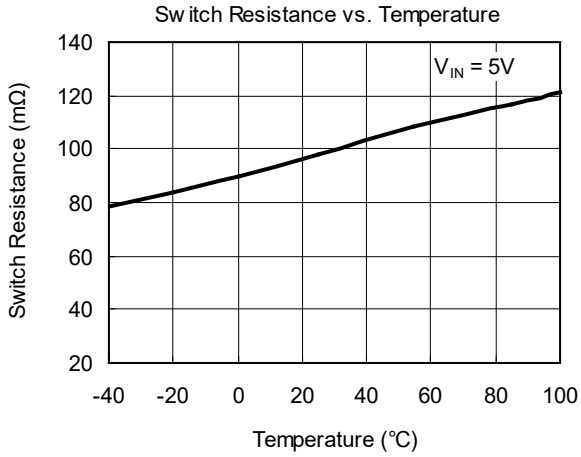



**TYPICAL PERFORMANCE CHARACTERISTICS (continued)**

At  $T_A = +25^\circ\text{C}$ ,  $V_{IN} = V_{EN} = 5\text{V}$ ,  $C_{IN} = C_{OUT} = 1\mu\text{F}$ , unless otherwise noted.

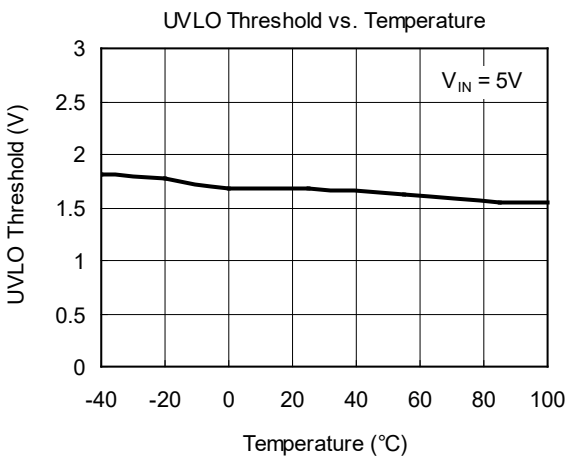
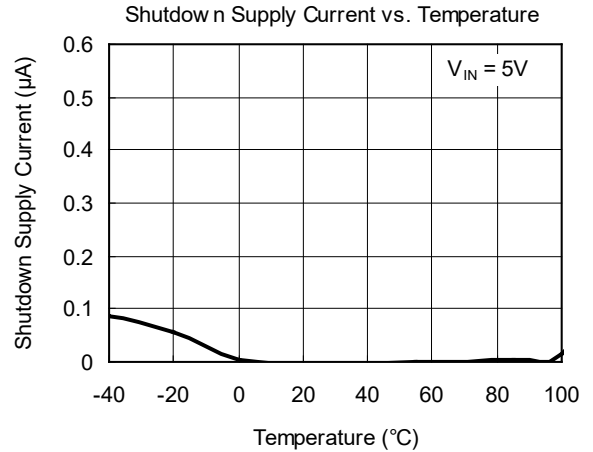
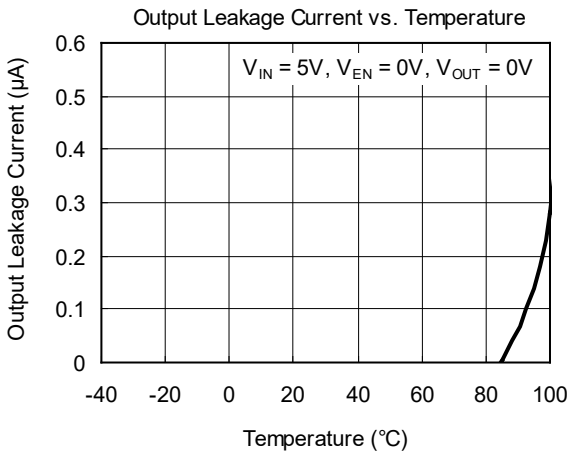
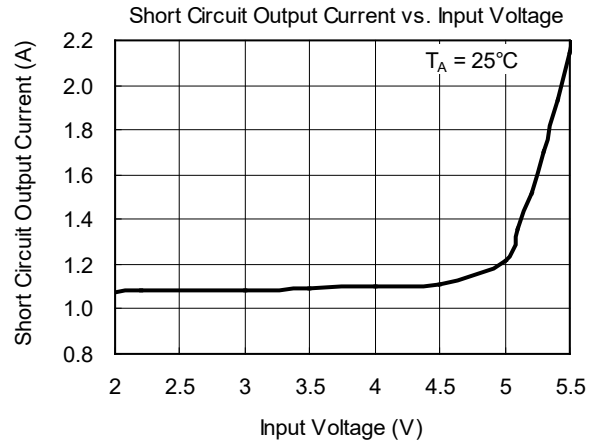
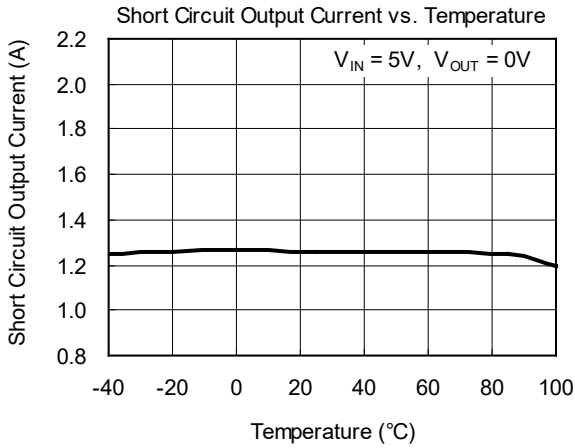

## FUNCTIONAL DESCRIPTION

The SGM2554 is a high-side single N-Channel MOSFET switch and SGM2554A has active-high enable input.

### Input and Output

VIN (input) is the power supply connection to the circuitry and the drain of the output MOSFET. VOUT (output) is the source of the output MOSFET. In a typical circuit, current flows through the switch from VIN to VOUT toward the load. Both VOUT pins must be short on the board and connected to the load and so do both VIN pins but connected to the power source.

### Thermal Shutdown

Thermal shutdown shuts off the output MOSFET if the die temperature exceeds 125°C until the die temperature drops to 105°C.

### Soft-Start

In order to eliminate the upstream voltage droop caused by the large inrush current during hot-plug events, the “soft-start” feature effectively isolates power supplies from such highly capacitive loads.

### Under-Voltage Lockout (UVLO)

UVLO prevents the MOSFET switch from turning on until input voltage exceeds 1.65V (TYP). If input voltage drops below 1.6V (TYP), UVLO shuts off the MOSFET switch.

### Reverse-Voltage Protection

The reverse-voltage protection feature turns off the N-MOSFET switch whenever the output voltage exceeds the input voltage by 120mV (TYP). The SGM2554 keeps the N-MOSFET turned off until the output voltage is lower than the input voltage by 35mV (TYP) or the chip enable is toggled.

### Current Limiting and Short Protection

The current limit circuit is designed to limit the output current to protect the system supply. The current limit threshold is set internally to approximately 1.85A (TYP).

When the output is shorted to ground, it will be limited to 1.1A until thermal shutdown or short condition is removed.

### Power Dissipation

The device's junction temperature depends on several factors such as the load, PCB layout, ambient temperature, and package type. Equations that can be used to calculate power dissipation and junction temperature are found below:

$$P_D = R_{DS(ON)} \times I_{OUT}^2$$

To relate this to junction temperature, the following equation can be used:

$$T_J = P_D \times \theta_{JA} + T_A$$

where:

$T_J$  = junction temperature

$T_A$  = ambient temperature

$\theta_{JA}$  = the thermal resistance of the package

APPLICATION INFORMATION

Filtering

To limit the input voltage drop during hot-plug events, connect a 1µF ceramic capacitor from VIN to GND. However, higher capacitor values will further reduce the voltage drop at the input.

Connect a sufficiently large capacitor from VOUT to GND. This capacitor helps to prevent inductive parasitics from pulling VOUT negative during turn-off or EMI damage to other components during the hot-detachment. It is also necessary for meeting the USB specification during hot plug-in operation. If SGM2554 is implanted in device end application, minimum 1µF capacitor from VOUT to GND is recommended and higher capacitor values are also preferred.

In choosing these capacitors, special attention must be paid to the Effective Series Resistance (ESR) of the capacitors, to minimize the IR drop across the capacitor ESR. A lower ESR on this capacitor can get a lower IR drop during the operation.

Ferrite beads in series with all power and ground lines are recommended to eliminate or significantly reduce EMI. In selecting a ferrite bead, the DC resistance of the wire used must be kept to a minimum to reduce the voltage drop.

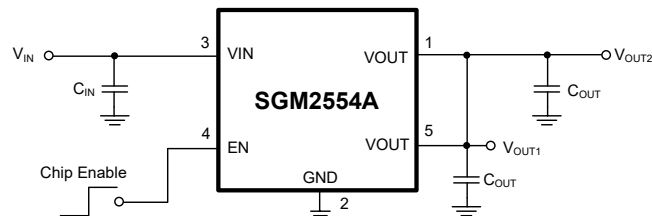

C<sub>IN</sub> = 1µF, C<sub>OUT</sub> = 470µF (Low ESR) on M/B  
 C<sub>IN</sub> = 1µF, C<sub>OUT</sub> = 330µF (Low ESR) on Notebook  
 C<sub>IN</sub> = 10µF, C<sub>OUT</sub> = 1µF on USB Device

Figure 1. High-side Power Switch with Chip Enable Control

Layout and Thermal Dissipation

- Place the switch as close to the USB connector as possible. Keep all traces as short as possible to reduce the effect of undesirable parasitic inductance.
- Place the output capacitor and ferrite beads as close as possible to the USB connector.
- If ferrite beads are used, use wires with minimum resistance and large solder pads to minimize connection resistance.
- If the package is with dual VOUT or VIN pins, short both the same function pins as in Figure 1 or Figure 2 to reduce the internal turn-on resistance. If the output power will be delivered to two individual ports, it is specially necessary to short both VOUT pins at the switch output side in order to protect the switch when each port is plugged-in separately.
- Under normal operating conditions, the package can dissipate the channel heat away. Wide power-bus planes connected to VIN and VOUT and a ground plane in contact with the device will help dissipate additional heat.

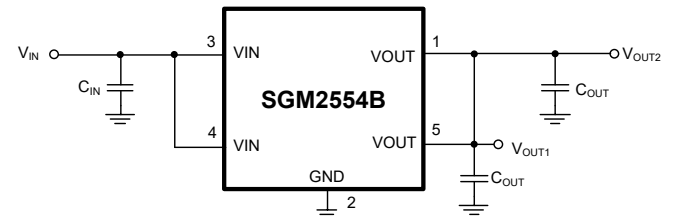

C<sub>IN</sub> = 1µF, C<sub>OUT</sub> = 470µF (Low ESR) on M/B  
 C<sub>IN</sub> = 1µF, C<sub>OUT</sub> = 330µF (Low ESR) on Notebook  
 C<sub>IN</sub> = 10µF, C<sub>OUT</sub> = 1µF on USB Device

Figure 2. High-side Power Switch

**REVISION HISTORY**

NOTE: Page numbers for previous revisions may differ from page numbers in the current version.

**DECEMBER 2017 – REV.A.2 to REV.A.3**

---

Update Feature section ..... 1

---

**APRIL 2016 – REV.A.1 to REV.A.2**

---

New version.....All

---

**JANUARY 2014 – REV.A to REV.A.1**

---

Changed Electrical Characteristics section .....4

---

**Changes from Original (MAY 2013) to REV.A**

---

Changed from product preview to production data.....All

---

PACKAGE OUTLINE DIMENSIONS

SOT-23-5

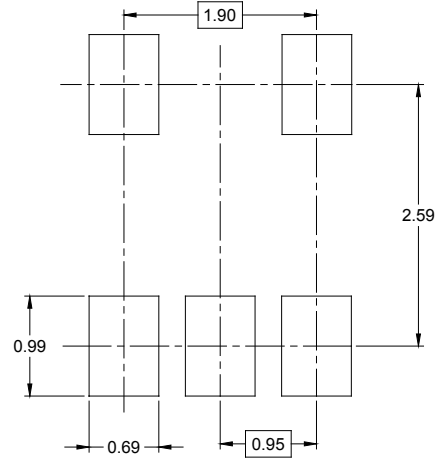
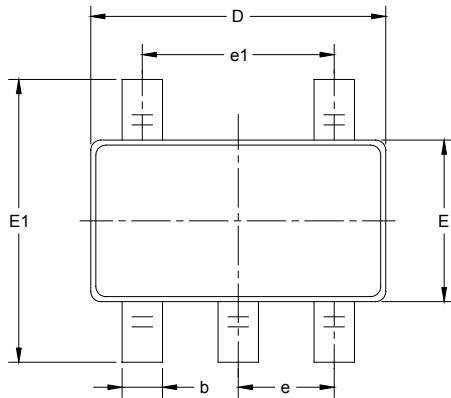

RECOMMENDED LAND PATTERN (Unit: mm)

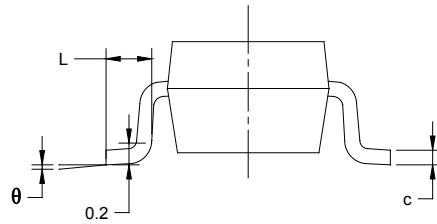
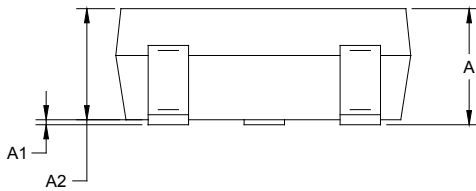

Symbol	Dimensions In Millimeters		Dimensions In Inches	
	MIN	MAX	MIN	MAX
A	1.050	1.250	0.041	0.049
A1	0.000	0.100	0.000	0.004
A2	1.050	1.150	0.041	0.045
b	0.300	0.500	0.012	0.020
c	0.100	0.200	0.004	0.008
D	2.820	3.020	0.111	0.119
E	1.500	1.700	0.059	0.067
E1	2.650	2.950	0.104	0.116
e	0.950 BSC		0.037 BSC	
e1	1.900 BSC		0.075 BSC	
L	0.300	0.600	0.012	0.024
$\theta$	0°	8°	0°	8°

# PACKAGE INFORMATION

## TAPE AND REEL INFORMATION

### REEL DIMENSIONS



### TAPE DIMENSIONS



NOTE: The picture is only for reference. Please make the object as the standard.

### KEY PARAMETER LIST OF TAPE AND REEL

Package Type	Reel Diameter	Reel Width W1 (mm)	A0 (mm)	B0 (mm)	K0 (mm)	P0 (mm)	P1 (mm)	P2 (mm)	W (mm)	Pin1 Quadrant
SOT-23-5	7"	9.5	3.20	3.20	1.40	4.0	4.0	2.0	8.0	Q3

DD0001

# PACKAGE INFORMATION

## CARTON BOX DIMENSIONS



NOTE: The picture is only for reference. Please make the object as the standard.

## KEY PARAMETER LIST OF CARTON BOX

Reel Type	Length (mm)	Width (mm)	Height (mm)	Pizza/Carton
7" (Option)	368	227	224	8
7"	442	410	224	18

DD0002