

GENERAL DESCRIPTION

The SGM2566C is an ultra-low on-resistance, integrated N-MOSFET, single-channel load switch. The device can operate over a wide input voltage range of 0.6V to 5.7V. It can support a 5A maximum continuous load current and is controlled by a switch enable input (ON) pin. The V_{OUT} rise time can be programmed by setting an additional capacitor to the SS pin.

The SGM2566C has a thermal shutdown function. When the junction temperature exceeds +165°C, the inner N-MOSFET will be turned off through the thermal shutdown circuitry, and will remain off until the die temperature drops below +140°C. The device also has quick output discharge function when the switch is disabled.

The SGM2566C is available in a Green TDFN-2×2-8AL package.

FEATURES

- **Input Voltage Range: 0.6V to V_{BIAS}**
- **V_{BIAS} Voltage Range: 2.5V to 5.7V**
- **Ultra-Low On-Resistance: 14mΩ (TYP)**
- **Maximum Continuous Load Current: 5A**
- **Quiescent Current: 12μA (TYP)**
- **Thermal Shutdown**
- **Programmable Output Ramp Time**
- **Support with 1.2V, 1.8V, 2.5V and 3.3V GPIOs**
- **Quick Output Discharge**
- **-40°C to +105°C Operating Temperature Range**
- **Available in a Green TDFN-2×2-8AL Package**

APPLICATIONS

- Ultrabook
- Netbook
- Notebook and Tablet Computer

TYPICAL APPLICATION

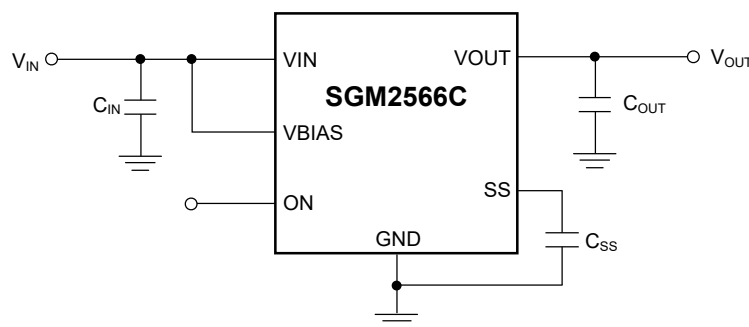

Figure 1. Typical Application Circuit

PACKAGE/ORDERING INFORMATION

MODEL	PACKAGE DESCRIPTION	SPECIFIED TEMPERATURE RANGE	ORDERING NUMBER	PACKAGE MARKING	PACKING OPTION
SGM2566C	TDFN-2×2-8AL	-40°C to +105°C	SGM2566CGTDE8G/TR	GAJ XXXX	Tape and Reel, 3000

MARKING INFORMATION

NOTE: XXXXX = Date Code, Trace Code and Vendor Code.

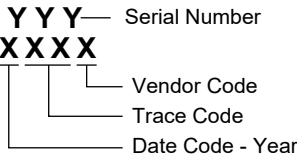

Green (RoHS & HSF): SG Micro Corp defines "Green" to mean Pb-Free (RoHS compatible) and free of halogen substances. If you have additional comments or questions, please contact your SGMICRO representative directly.

ABSOLUTE MAXIMUM RATINGS

Input Voltage, V_{IN}	-0.3V to 6V
Bias Voltage, V_{BIAS}	-0.3V to 6V
Output Voltage, V_{OUT}	-0.3V to 6V
ON Pin Voltage, V_{ON}	-0.3V to 6V
Maximum Continuous Load Current.....	5A
Maximum Pulsed Switch Current, Pulse < 300μs, 2% Duty Cycle.....	8A
Package Thermal Resistance	
TDFN-2×2-8AL, θ_{JA}	96°C/W
TDFN-2×2-8AL, θ_{JB}	37°C/W
TDFN-2×2-8AL, θ_{JC}	92°C/W
Junction Temperature.....	+150°C
Storage Temperature Range.....	-65°C to +150°C
Lead Temperature (Soldering, 10s).....	+260°C
ESD Susceptibility	
HBM.....	4000V
CDM.....	1000V

RECOMMENDED OPERATING CONDITIONS

Input Voltage, V_{IN}	0.6V to V_{BIAS}
Bias Voltage, V_{BIAS}	2.5V to 5.7V
Output Voltage, V_{OUT}	< V_{IN}
ON Pin Voltage, V_{ON}	0V to 5.7V
High Level Input Voltage, V_{IH}	
$V_{BIAS} = 2.5V$ to 5V, $T_J < +85^\circ C$	1.05V to 5.7V
$V_{BIAS} = 2.5V$ to 5V, $T_J < +105^\circ C$	1.1V to 5.7V
$V_{BIAS} = 5V$ to 5.7V, $T_J < +105^\circ C$	1.2V to 5.7V
Low Level Input Voltage, V_{IL}	
$V_{BIAS} = 2.5V$ to 5.7V.....	0V to 0.4V
Input Capacitor, C_{IN}	1μF (MIN)
Operating Junction Temperature Range.....	-40°C to +105°C

OVERSTRESS CAUTION

Stresses beyond those listed in Absolute Maximum Ratings may cause permanent damage to the device. Exposure to absolute maximum rating conditions for extended periods may affect reliability. Functional operation of the device at any conditions beyond those indicated in the Recommended Operating Conditions section is not implied.

ESD SENSITIVITY CAUTION

This integrated circuit can be damaged if ESD protections are not considered carefully. SGMICRO recommends that all integrated circuits be handled with appropriate precautions. Failure to observe proper handling and installation procedures can cause damage. ESD damage can range from subtle performance degradation to complete device failure. Precision integrated circuits may be more susceptible to damage because even small parametric changes could cause the device not to meet the published specifications.

DISCLAIMER

SG Micro Corp reserves the right to make any change in circuit design, or specifications without prior notice.

PIN CONFIGURATION

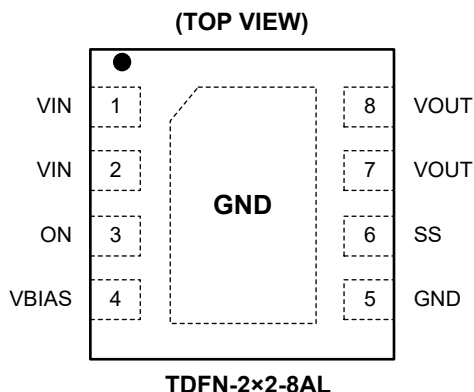

PIN DESCRIPTION

PIN	NAME	I/O	DESCRIPTION
1, 2	VIN	I	Switch Input Pins. They should be tied together, using a bypass capacitor (C_{IN}) as close as possible between this pin and GND pin.
3	ON	I	Switch Enable Input. Logic high sets the device active, logic low disables it and turns it into shutdown mode. Do not leave this pin floating.
4	VBIAS	I	Power Supply Pin for Internal Circuitry. V_{BIAS} voltage range is from 2.5V to 5.7V. It is recommended to decouple V_{BIAS} with 0.1μF or greater ceramic capacitor.
5	GND	G	Ground.
6	SS	O	Soft-Start Pin. A capacitor between this pin and GND determines the slew rate of V_{OUT} . The capacitor voltage rating used on this pin must be 10V or above. It also can be left floating.
7, 8	VOUT	O	Switch Output Pins. They should be tied together.
Exposed Pad	GND	G	Ground.

NOTE: I: input, O: output, G: ground.

ELECTRICAL CHARACTERISTICS(T_J = -40°C to +105°C, V_{BIAS} = 5V, typical values are at T_J = +25°C, unless otherwise noted.)

PARAMETER	SYMBOL	CONDITIONS	MIN	TYP	MAX	UNITS	
Power Supplies and Currents							
Bias Voltage Range	V _{BIAS}		2.5		5.7	V	
Input Voltage Range	V _{IN}		0.6		5.7	V	
VBIAS Quiescent Current	I _{Q_VBIAS}	I _{OUT} = 0mA, V _{IN} = V _{ON} = 5V		12	21	μA	
VBIAS Shutdown Current	I _{SD_VBIAS}	V _{ON} = V _{OUT} = 0V			1	μA	
VIN Shutdown Current	I _{SD_VIN}	V _{ON} = V _{OUT} = 0V	V _{IN} = 5V, T _J = -40°C to +85°C		0.019	1.4	μA
			V _{IN} = 5V, T _J = -40°C to +105°C			4.1	
			V _{IN} = 3.3V, T _J = -40°C to +85°C		0.007	0.9	
			V _{IN} = 3.3V, T _J = -40°C to +105°C			2.8	
			V _{IN} = 1.8V, T _J = -40°C to +85°C		0.004	0.7	
			V _{IN} = 1.8V, T _J = -40°C to +105°C			2.1	
			V _{IN} = 0.6V, T _J = -40°C to +85°C		0.002	0.5	
			V _{IN} = 0.6V, T _J = -40°C to +105°C			1.6	
Logic Level Inputs							
ON Pin Input Leakage Current	I _{ON}	V _{ON} = 5.5V, T _J = -40°C to +105°C			0.1	μA	
ON Pin Hysteresis	V _{ON_HYS}	V _{IN} = 5V		40		mV	
Resistance Characteristics							
On-Resistance	R _{ON}	I _{OUT} = -0.2A	V _{IN} = 5V, T _J = +25°C		14	21	mΩ
			V _{IN} = 5V, T _J = -40°C to +85°C			24	
			V _{IN} = 5V, T _J = -40°C to +105°C			25	
			V _{IN} = 3.3V, T _J = +25°C		14	21	mΩ
			V _{IN} = 3.3V, T _J = -40°C to +85°C			24	
			V _{IN} = 3.3V, T _J = -40°C to +105°C			25	
			V _{IN} = 1.8V, T _J = +25°C		14	21	mΩ
			V _{IN} = 1.8V, T _J = -40°C to +85°C			24	
			V _{IN} = 1.8V, T _J = -40°C to +105°C			25	
			V _{IN} = 1.5V, T _J = +25°C		14	21	mΩ
			V _{IN} = 1.5V, T _J = -40°C to +85°C			24	
			V _{IN} = 1.5V, T _J = -40°C to +105°C			25	
			V _{IN} = 1.05V, T _J = +25°C		14	21	mΩ
			V _{IN} = 1.05V, T _J = -40°C to +85°C			24	
			V _{IN} = 1.05V, T _J = -40°C to +105°C			25	
			V _{IN} = 0.6V, T _J = +25°C		14	21	mΩ
			V _{IN} = 0.6V, T _J = -40°C to +85°C			24	
			V _{IN} = 0.6V, T _J = -40°C to +105°C			25	
Quick Discharge Resistor							
Output Shutdown Discharge Resistance	R _{DIS}	V _{IN} = 5V, V _{ON} = 0V		140	210	Ω	
Thermal Shutdown							
Thermal Shutdown Temperature	T _{SD}	T _J increasing		165		°C	
Thermal Shutdown Hysteresis	T _{SD_HYS}	T _J falling		25		°C	

ELECTRICAL CHARACTERISTICS (continued)(T_J = -40°C to +105°C, V_{BIAS} = 2.5V, typical values are at T_J = +25°C, unless otherwise noted.)

PARAMETER	SYMBOL	CONDITIONS	MIN	TYP	MAX	UNITS	
Power Supplies and Currents							
VBIAS Quiescent Current	I _{Q_BIAS}	I _{OUT} = 0mA, V _{IN} = V _{ON} = 2.5V		8.5	16.5	μA	
VBIAS Shutdown Current	I _{SD_BIAS}	V _{OUT} = V _{ON} = 0V			1	μA	
VIN Shutdown Current	I _{SD_IN}	V _{OUT} = V _{ON} = 0V	V _{IN} = 2.5V, T _J = -40°C to +85°C	0.006	0.8	μA	
			V _{IN} = 2.5V, T _J = -40°C to +105°C		2.4		
			V _{IN} = 1.8V, T _J = -40°C to +85°C	0.004	0.7		
			V _{IN} = 1.8V, T _J = -40°C to +105°C		2.1		
			V _{IN} = 1.05V, T _J = -40°C to +85°C	0.003	0.6		
			V _{IN} = 1.05V, T _J = -40°C to +105°C		1.8		
			V _{IN} = 0.6V, T _J = -40°C to +85°C	0.002	0.5		
			V _{IN} = 0.6V, T _J = -40°C to +105°C		1.6		
Logic Level Inputs							
ON Input Leakage Current	I _{ON}	V _{ON} = 5.5V			0.1	μA	
ON Hysteresis	V _{HYS}	V _{IN} = 2.5V		40		mV	
Resistance Characteristics							
On-Resistance	R _{ON}	I _{OUT} = -0.2A	V _{IN} = 2.5V, T _J = +25°C		14	21	mΩ
			V _{IN} = 2.5V, T _J = -40°C to +85°C			24	
			V _{IN} = 2.5V, T _J = -40°C to +105°C			25	
			V _{IN} = 1.8V, T _J = +25°C		14	21	mΩ
			V _{IN} = 1.8V, T _J = -40°C to +85°C			24	
			V _{IN} = 1.8V, T _J = -40°C to +105°C			25	
			V _{IN} = 1.5V, T _J = +25°C		14	21	mΩ
			V _{IN} = 1.5V, T _J = -40°C to +85°C			24	
			V _{IN} = 1.5V, T _J = -40°C to +105°C			25	
			V _{IN} = 1.2V, T _J = +25°C		14	21	mΩ
			V _{IN} = 1.2V, T _J = -40°C to +85°C			24	
			V _{IN} = 1.2V, T _J = -40°C to +105°C			25	
			V _{IN} = 0.6V, T _J = +25°C		14	21	mΩ
			V _{IN} = 0.6V, T _J = -40°C to +85°C			24	
			V _{IN} = 0.6V, T _J = -40°C to +105°C			25	
			Quick Discharge Resistor				
Output Shutdown Discharge Resistance	R _{DIS}	V _{IN} = 2.5V, V _{ON} = 0V		165	230	Ω	

SWITCHING CHARACTERISTICS

(Typical values are at T_J = +25°C, unless otherwise noted.)

PARAMETER	SYMBOL	CONDITIONS	MIN	TYP	MAX	UNITS
V_{IN} = V_{BIAS} = 5V, V_{ON} = 5V						
Turn-On Time	t _{ON}	R _L = 10Ω, C _{OUT} = 0.1μF, C _{IN} = 1μF, C _{SS} = 1000pF		1500		μs
Turn-Off Time	t _{OFF}	R _L = 10Ω, C _{OUT} = 0.1μF, C _{IN} = 1μF, C _{SS} = 1000pF		9		
V _{OUT} Rise Time	t _R	R _L = 10Ω, C _{OUT} = 0.1μF, C _{IN} = 1μF, C _{SS} = 1000pF		1700		
V _{OUT} Fall Time	t _F	R _L = 10Ω, C _{OUT} = 0.1μF, C _{IN} = 1μF, C _{SS} = 1000pF		3		
On Delay Time	t _D	R _L = 10Ω, C _{OUT} = 0.1μF, C _{IN} = 1μF, C _{SS} = 1000pF		660		
V_{IN} = 0.6V, V_{BIAS} = 5V, V_{ON} = 5V						
Turn-On Time	t _{ON}	R _L = 10Ω, C _{OUT} = 0.1μF, C _{IN} = 1μF, C _{SS} = 1000pF		620		μs
Turn-Off Time	t _{OFF}	R _L = 10Ω, C _{OUT} = 0.1μF, C _{IN} = 1μF, C _{SS} = 1000pF		8		
V _{OUT} Rise Time	t _R	R _L = 10Ω, C _{OUT} = 0.1μF, C _{IN} = 1μF, C _{SS} = 1000pF		280		
V _{OUT} Fall Time	t _F	R _L = 10Ω, C _{OUT} = 0.1μF, C _{IN} = 1μF, C _{SS} = 1000pF		3		
On Delay Time	t _D	R _L = 10Ω, C _{OUT} = 0.1μF, C _{IN} = 1μF, C _{SS} = 1000pF		490		
V_{IN} = V_{BIAS} = 2.5V, V_{ON} = 5V						
Turn-On Time	t _{ON}	R _L = 10Ω, C _{OUT} = 0.1μF, C _{IN} = 1μF, C _{SS} = 1000pF		2400		μs
Turn-Off Time	t _{OFF}	R _L = 10Ω, C _{OUT} = 0.1μF, C _{IN} = 1μF, C _{SS} = 1000pF		39		
V _{OUT} Rise Time	t _R	R _L = 10Ω, C _{OUT} = 0.1μF, C _{IN} = 1μF, C _{SS} = 1000pF		2300		
V _{OUT} Fall Time	t _F	R _L = 10Ω, C _{OUT} = 0.1μF, C _{IN} = 1μF, C _{SS} = 1000pF		8		
On Delay Time	t _D	R _L = 10Ω, C _{OUT} = 0.1μF, C _{IN} = 1μF, C _{SS} = 1000pF		1300		
V_{IN} = 0.6V, V_{BIAS} = 2.5V, V_{ON} = 5V						
Turn-On Time	t _{ON}	R _L = 10Ω, C _{OUT} = 0.1μF, C _{IN} = 1μF, C _{SS} = 1000pF		1400		μs
Turn-Off Time	t _{OFF}	R _L = 10Ω, C _{OUT} = 0.1μF, C _{IN} = 1μF, C _{SS} = 1000pF		35		
V _{OUT} Rise Time	t _R	R _L = 10Ω, C _{OUT} = 0.1μF, C _{IN} = 1μF, C _{SS} = 1000pF		700		
V _{OUT} Fall Time	t _F	R _L = 10Ω, C _{OUT} = 0.1μF, C _{IN} = 1μF, C _{SS} = 1000pF		4		
On Delay Time	t _D	R _L = 10Ω, C _{OUT} = 0.1μF, C _{IN} = 1μF, C _{SS} = 1000pF		1000		

PARAMETER MEASUREMENT INFORMATION

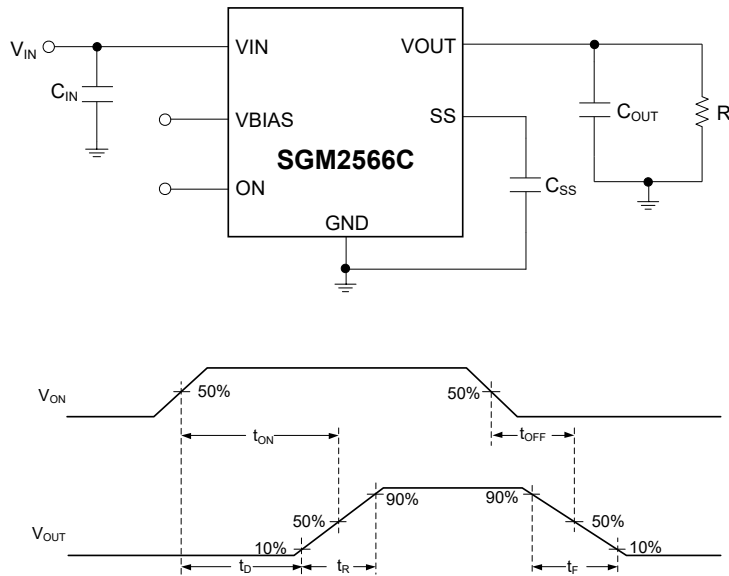
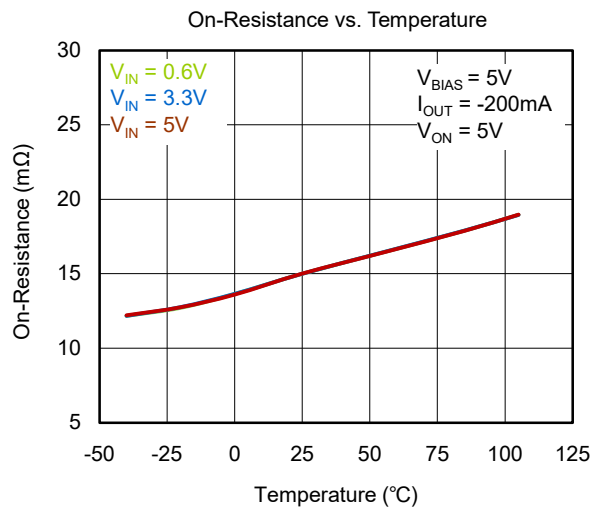
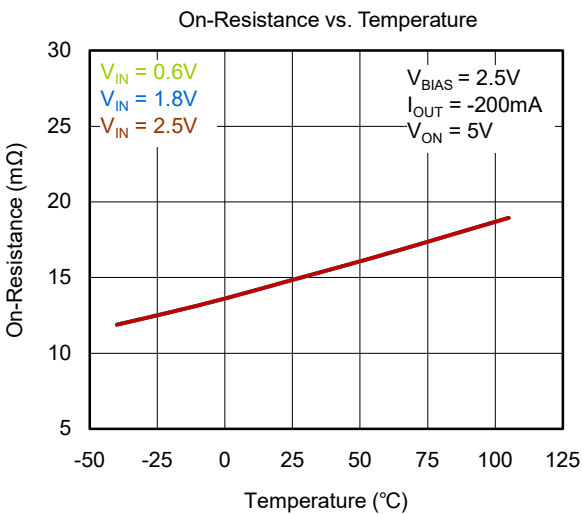
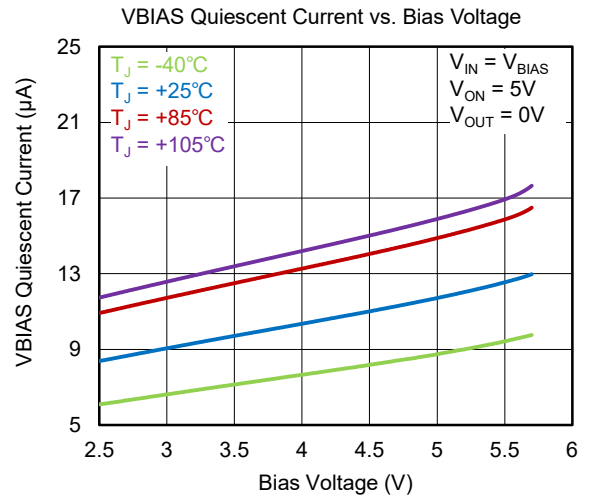
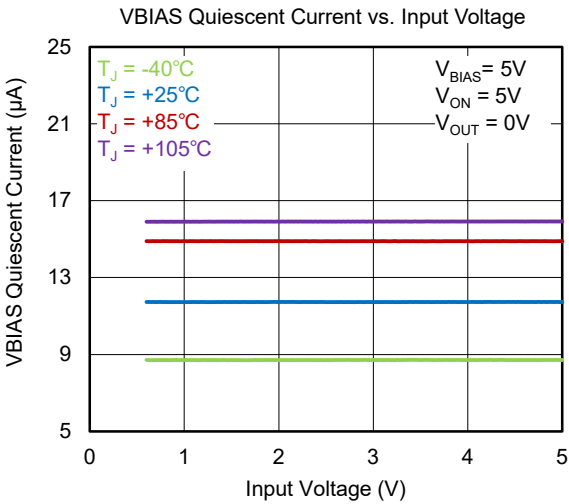
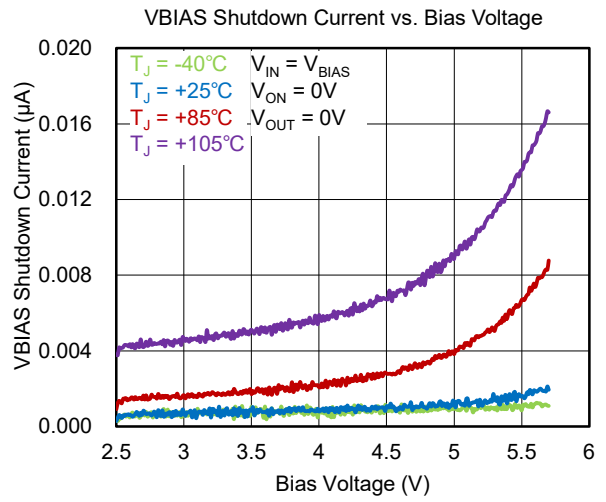
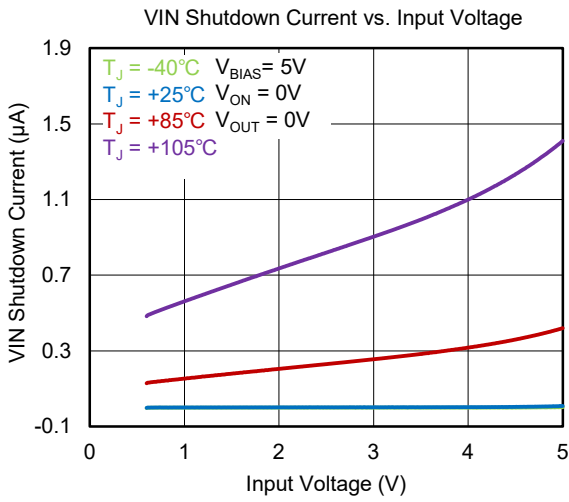
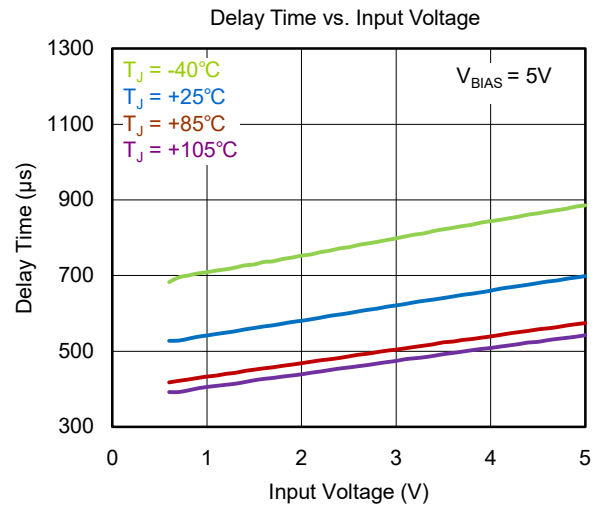
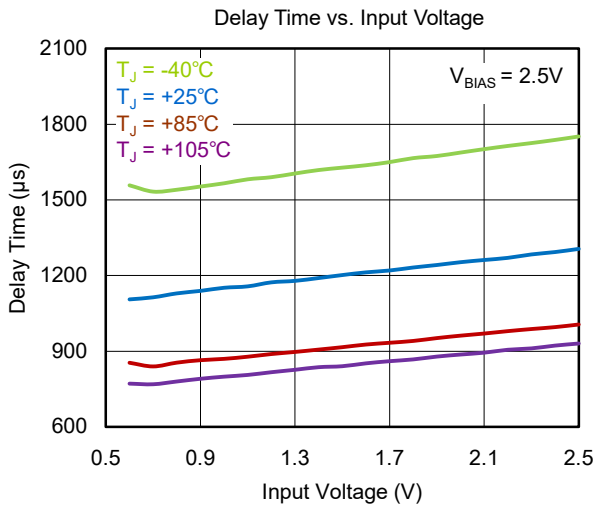
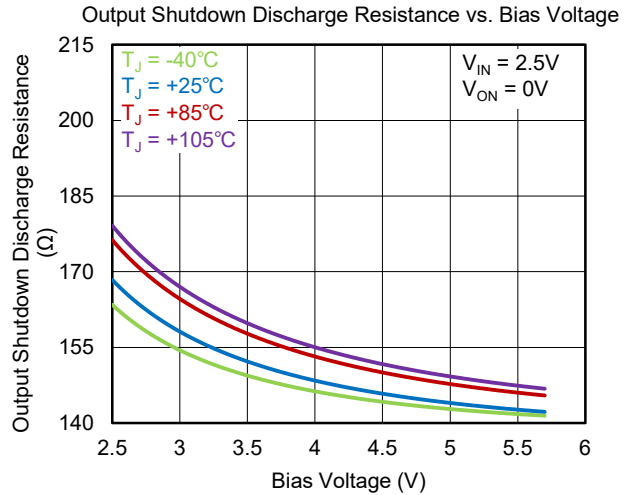
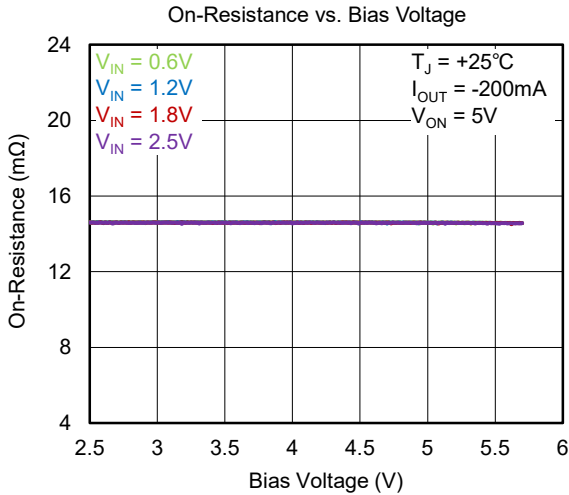
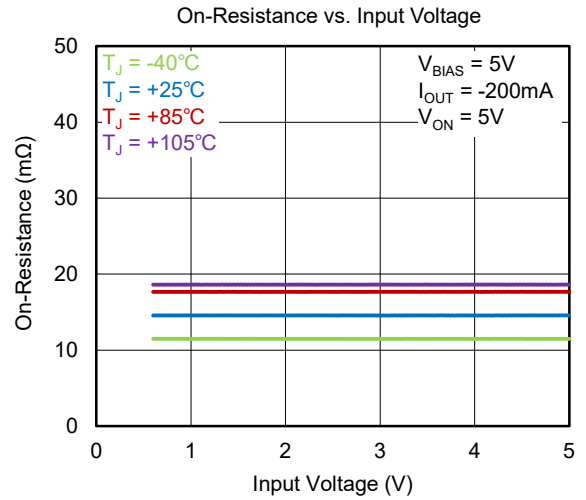
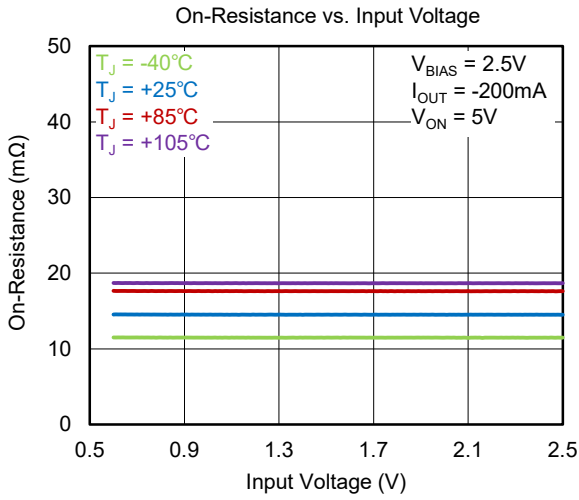

Figure 2. Turn-On and Turn-Off Waveforms

TYPICAL PERFORMANCE CHARACTERISTICS



TYPICAL PERFORMANCE CHARACTERISTICS (continued)



TYPICAL PERFORMANCE CHARACTERISTICS (continued)

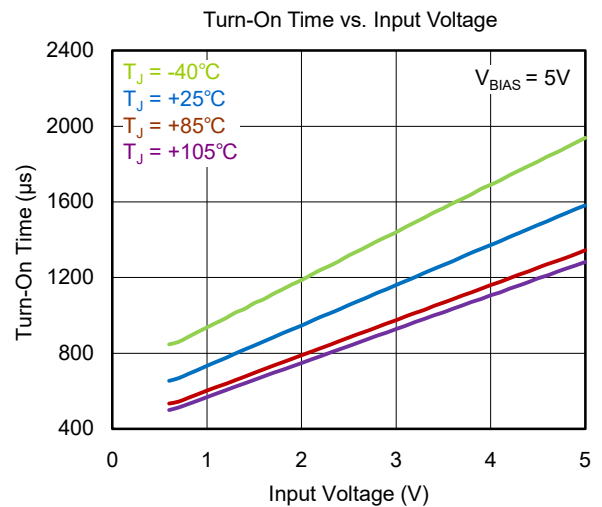
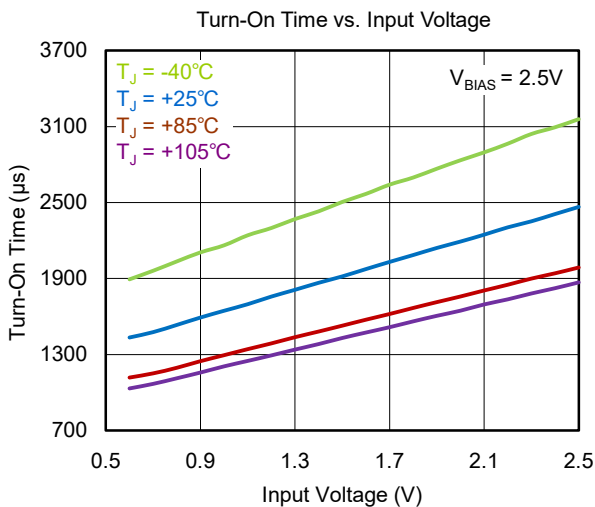
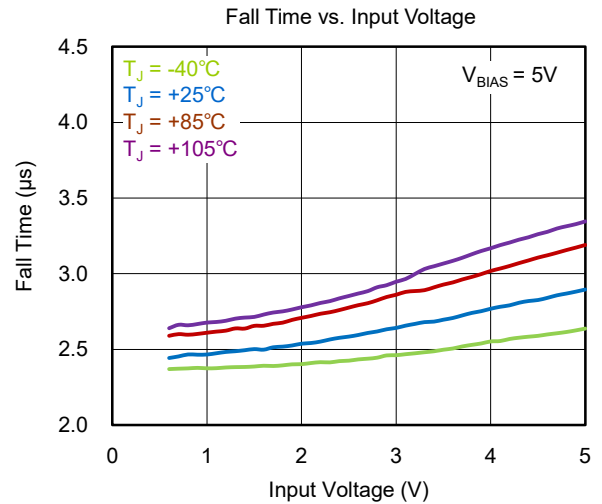
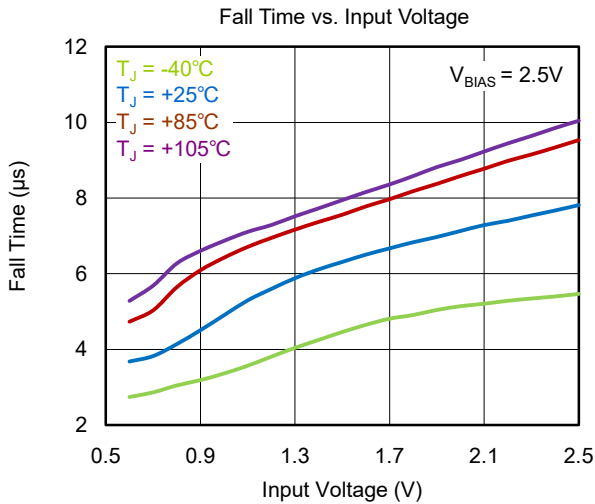
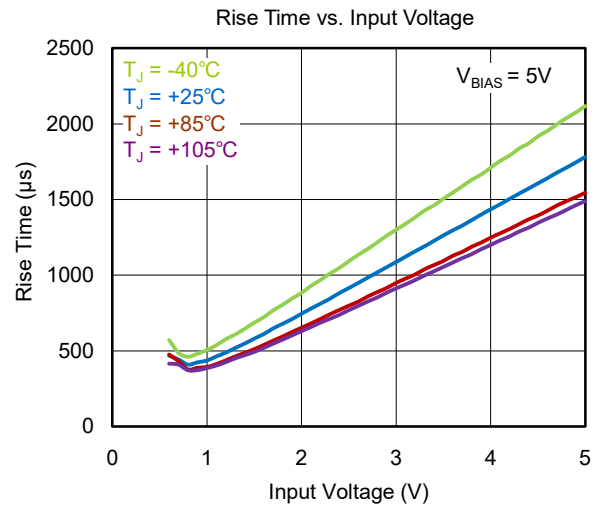
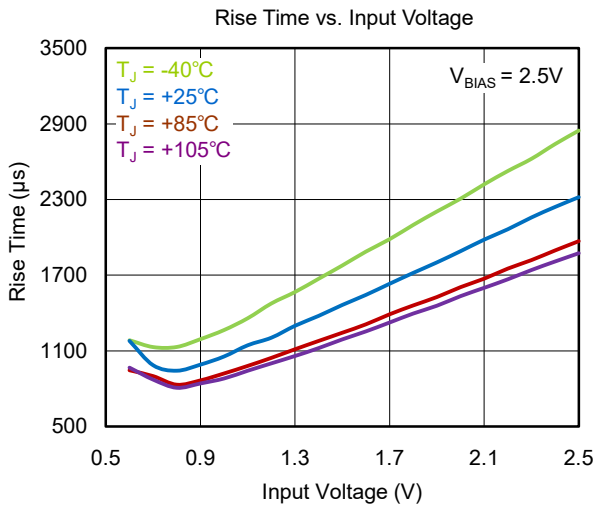

TYPICAL PERFORMANCE CHARACTERISTICS (continued)

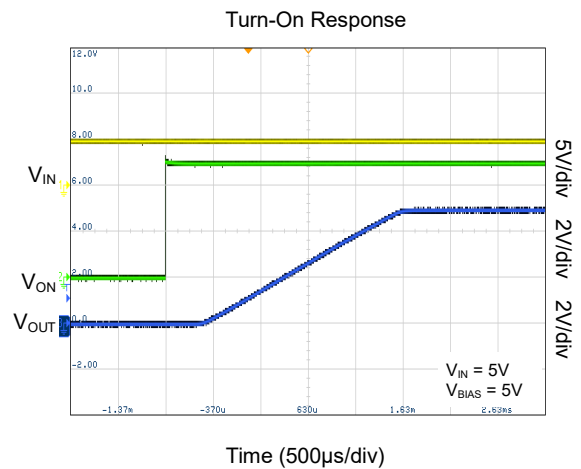
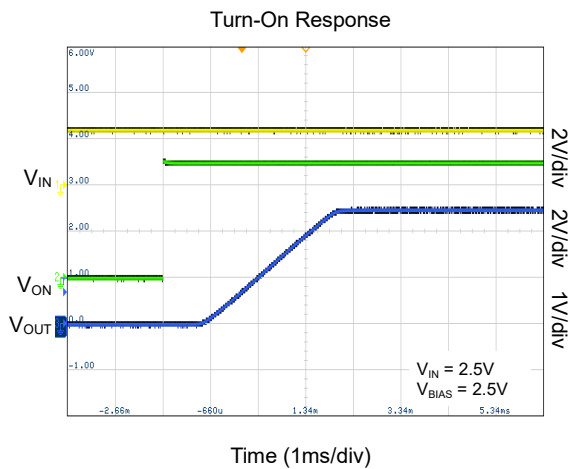
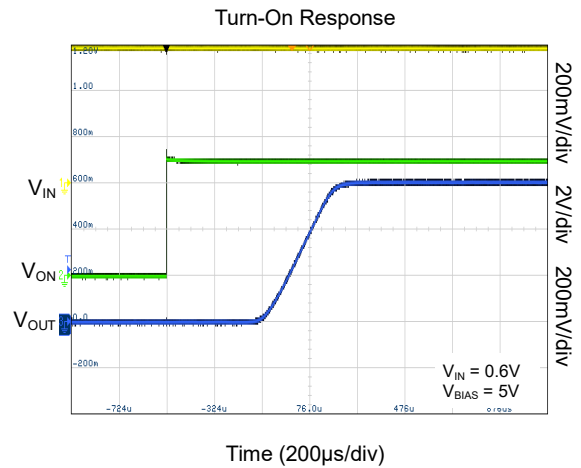
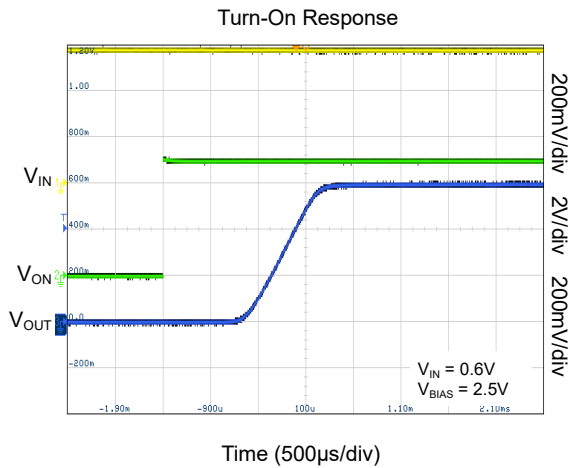
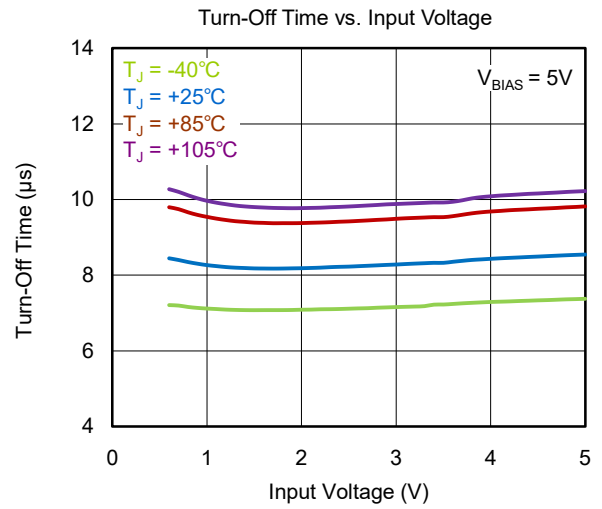
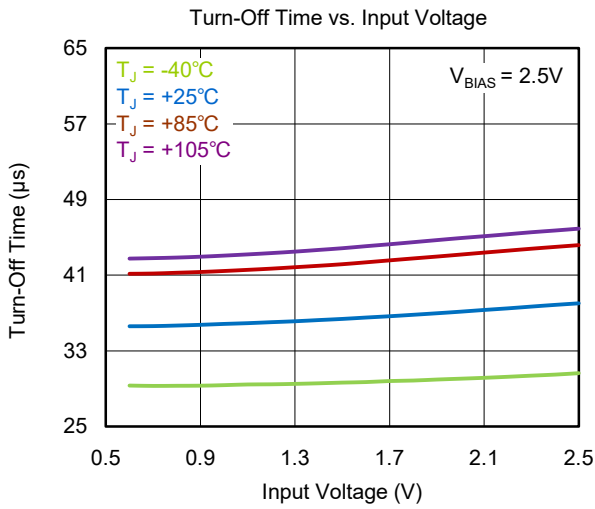

TYPICAL PERFORMANCE CHARACTERISTICS (continued)

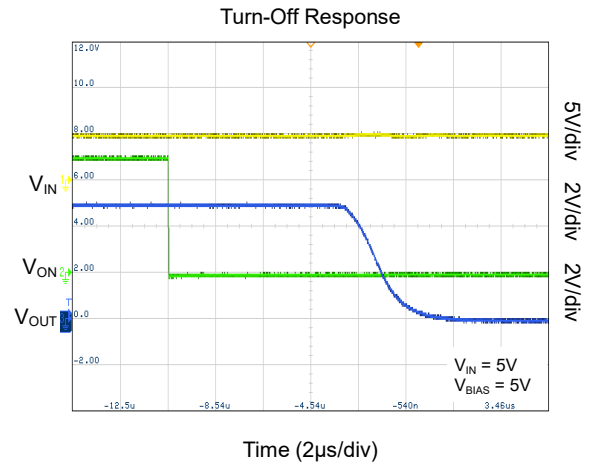
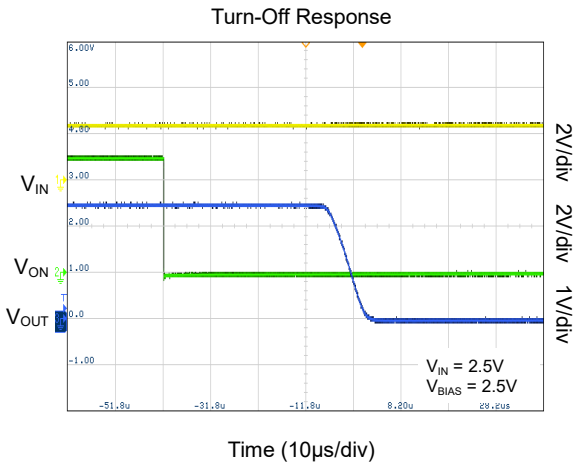
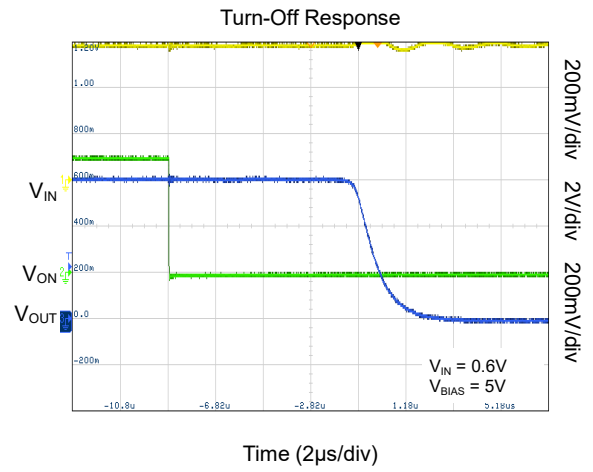
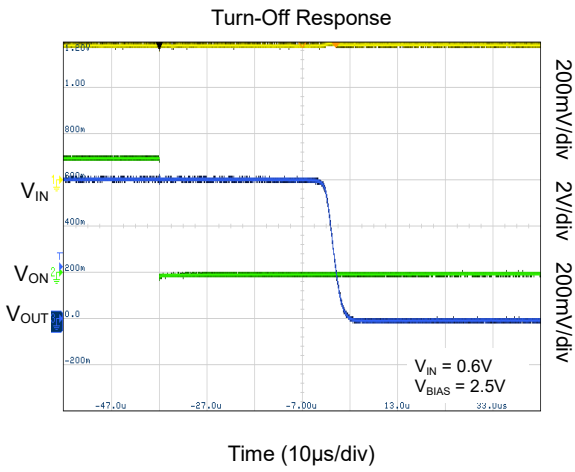

FUNCTIONAL BLOCK DIAGRAM

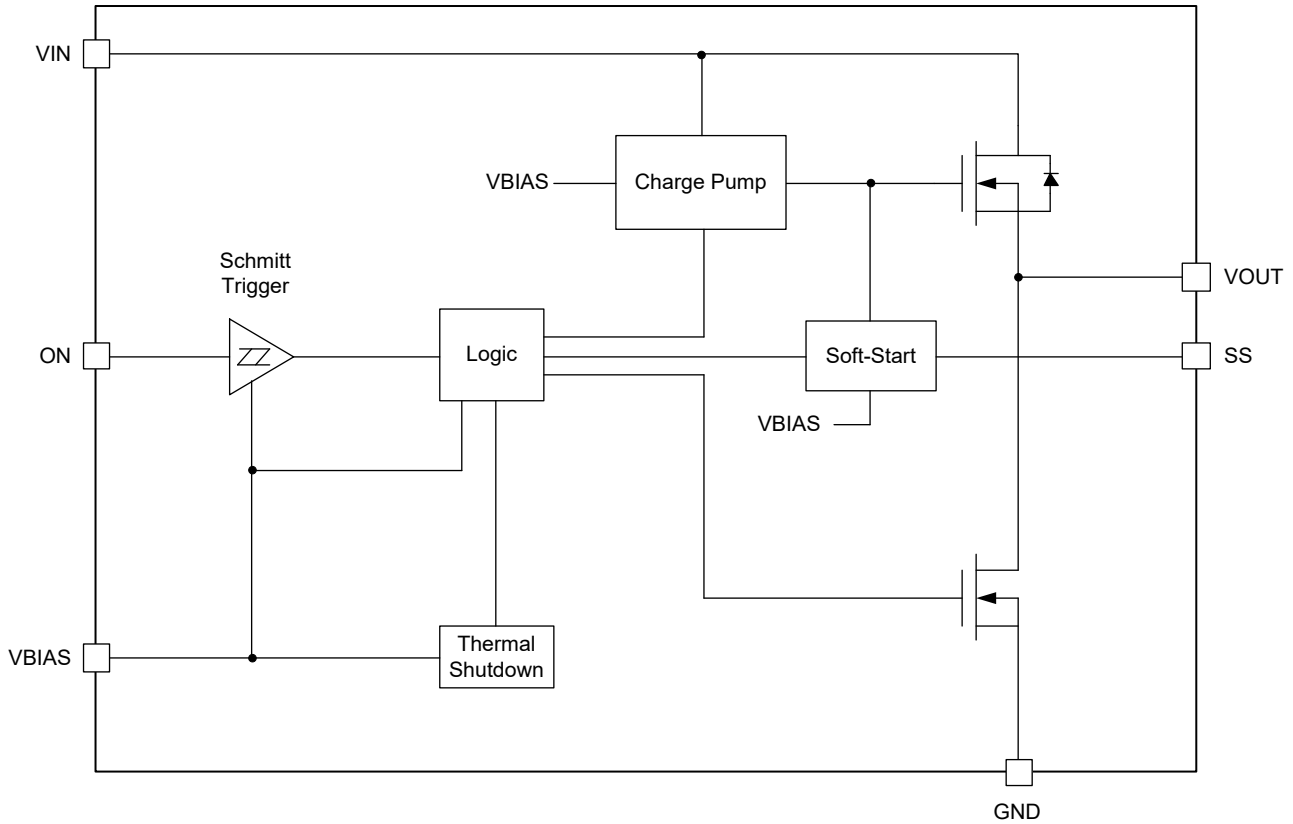

Figure 3. Block Diagram

DETAILED DESCRIPTION

Overview

The SGM2566C is a 5.7V, 14mΩ (TYP) on-resistance, integrated N-MOSFET, single-channel load switch. It can support a 5A maximum continuous load current and be enabled by the ON pin. The device has control pin to set the slew rate (or the soft-start time) of V_{OUT}, which can control the inrush current and reduce the voltage drop. The device also has the thermal shutdown function. The SGM2566C includes internal integrated quick output discharge (QOD) to remove the remaining charge from the output when the switch is disabled.

SGM2566C is highly integrated. Using SGM2566C can reduce the PCB area and the BOM count greatly, even the cost.

V_{BIAS} Power Supply

V_{BIAS} is the power supply to the inner circuit including control logic, quick output discharge and charge pump. The support voltage range is from 2.5V to 5.7V. For most applications, a 0.1μF capacitor is sufficient. It is recommended to use X5R or X7R dielectrics ceramic capacitor.

Input Capacitor

Turning on the N-MOSFET to charge load capacitor will generate inrush current, which may cause the V_{IN} drop. In order to prevent the drop, a capacitor must be placed between the VIN and GND pins. Usually, a 1μF input capacitor (C_{IN}) placed close to the pins is sufficient. However, higher capacitance values could further reduce the voltage drop. So, larger C_{IN} can be used to reduce the voltage drop in high current applications.

DETAILED DESCRIPTION (continued)

Output Capacitor

A 0.1μF output capacitor (C_{OUT}) should be placed between the VOUT and GND pins. This capacitor can prevent parasitic board inductance from forcing VOUT below GND when the switch is turned on. It is recommended that C_{IN} is greater than C_{OUT} .

Control Pin

There is a control pin ON to turn on or turn off the corresponding N-MOSFET. When the ON pin is driven high, the switch will be turned on, and when the ON pin is driven low, the switch will be turned off. The ON pin is compatible with standard GPIO logic level threshold, such as 1.2V, 1.8V, 2.5V or 3.3V.

The recommended start-up sequence is: V_{BIAS} power on first, then V_{IN} power on, and finally to enable the ON. Or V_{IN} and V_{BIAS} power on simultaneously, then the ON is enabled.

The ON pin cannot be left floating and must be connected to either high or low level as requirement.

Soft-Start Control

A capacitor between SS and GND pins determines the slew rate of VOUT. The slew rate can be calculated using the below equation.

$$SR = 0.4 \times C_{SS} \quad (1)$$

So, the soft-start time of VOUT is:

$$t_{SS} = SR \times V_{OUT} = 0.4 \times C_{SS} \times V_{OUT} \quad (2)$$

where:

SR is the slew rate (in μs/V).

C_{SS} is the capacitance value on the SS pin (in pF).

t_{SS} is the soft-start time of VOUT.

For the desired rise time performance, the capacitor voltage rating used on this pin must be 10V or above. When $C_{SS} < 100\text{pF}$, the equation cannot be applied. The recommended value of C_{SS} is bigger than 100pF. If $C_{SS} = 0\text{pF}$ or left floating, use Table 3 to determine rise times. The soft-start time is valid only when the ON pin is enabled after V_{IN} and V_{BIAS} are ready.

Quick Output Discharge (QOD)

The QOD feature is available for SGM2566C. The device has a resistor which is not activated to discharge by default. When the ON pin is pulled low or over-temperature happens, the resistor will be connected between the VOUT and GND to discharge the output quickly. This resistor pulls down the output and prevents it from floating when the switch is turned off.

Thermal Shutdown

Thermal shutdown protects the device from excessive temperature and can recovery automatically. When die temperature exceeds +165°C (TYP), the MOSFET will be shut down and remained off until die temperature drops below +140°C (TYP).

Device Functional Modes

The connection of the VOUT pin is shown in Table 1.

Table 1. SGM2566C Functions Table

ON	VIN to VOUT	VOUT
L	N-MOSFET Off	GND
H	N-MOSFET On	VIN

APPLICATION INFORMATION

Design Example

This example illustrates how to choose C_{SS} in details to limit inrush current within the requirement.

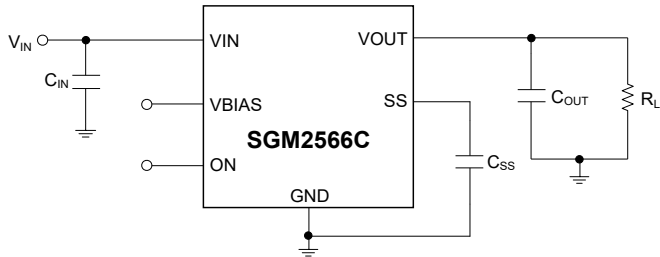

Figure 4. Typical Application Circuit

Design Requirements

Table 2 shows the SGM2566C design parameters.

Table 2. Design Parameters

Design Parameter	Value
Input Voltage (V _{IN})	3.3V
Bias Voltage (V _{BIAS})	5V
Load Capacitance (C _{OUT})	22μF
Maximum Acceptable Inrush Current (I _{INRUSH})	500mA

Detailed Design Procedure

Inrush Current

When the switch is enabled, V_{OUT} begins to soft-start from 0V linearly. Inrush current can be calculated by the following formula.

$$I_{INRUSH} = C_{OUT} \times dV_{OUT}/dt \tag{3}$$

Table 3. Rise Time vs. C_{SS} Capacitor

C _{SS} (pF)	Rise Time (μs) 10% - 90% ⁽¹⁾						
	V _{IN} = 0.6V	V _{IN} = 1.05V	V _{IN} = 1.2V	V _{IN} = 1.5V	V _{IN} = 1.8V	V _{IN} = 3.3V	V _{IN} = 5V
0	19	31	35	39	46	102	166
220	31	67	81	99	121	224	348
470	80	154	180	224	272	506	744
1000	186	340	390	490	580	1060	1570
2200	432	740	814	1066	1270	2360	3600
4700	1100	1900	2200	2660	3160	5520	8080
10000	2520	4020	4500	5440	6460	11500	17000

NOTE 1: Typical values are at T_J = +25°C, V_{BIAS} = 5V, C_{OUT} = 0.1μF, C_{IN} = 1μF, R_L = 10Ω, 10V X7R ±10% ceramic capacitor.

Soft-Start Time

From the Equation 3, soft-start time can be calculated.

$$t_{SS} = C_{OUT} \times V_{OUT}/I_{INRUSH} \tag{4}$$

In this example: C_{OUT} = 22μF, V_{OUT} = V_{IN} = 3.3V, I_{INRUSH} = 500mA.

So,

$$t_{SS} = 22\mu F \times 3.3V/500mA \approx 145.2\mu s \tag{5}$$

To ensure an inrush current is less than 500mA, the soft-start time cannot be less than 145.2μs. The next, choose a C_{SS} value to meet the desired soft-start time.

C_{SS} Selection

From equation,

$$t_{SS} = 0.4 \times C_{SS} \times V_{OUT} \tag{6}$$

C_{SS} ≈ 110pF can be calculated.

For safety margin, refer to Table 3. It is necessary to select 220pF capacitor.

The t_R (the rise time from 10% to 90% of V_{OUT}) at different C_{SS} has been measured under C_{OUT} = 0.1μF, C_{IN} = 1μF and R_L = 10Ω.

If t_{SS} is known, it can be calculated that t_R = 0.8 × t_{SS} ≈ 116.2μs. According to the t_R, look up Table 3 to get the recommended value C_{SS} which sets the rise time not be less than the calculated.

When C_{SS} is left floating, the rise times can be obtained from C_{SS} = 0pF listed in Table 3.

APPLICATION INFORMATION (continued)

Layout Guidelines

For the best operation of device, the following guidelines must be strictly followed:

- ♦ All high-current traces (VIN and VOUT) can be as short and wide as possible. It is recommended to use ground copper pour. Special attention should be paid to that size and number of via must be enough for a given current.
- ♦ The input and output capacitors should be placed as close as possible to the device.
- ♦ Decoupling capacitors of VBIAS should be placed next to the VBIAS pin.
- ♦ Place the C_{SS} capacitor close to the SS pin.
- ♦ Use sufficient thermal vias to directly connect the exposed thermal pad to the ground plane on the bottom layer under the body of IC, which can relieve the thermal further and achieve better thermal performance.

Thermal Considerations

Assuming a given ambient temperature and package thermal resistance, the maximum allowable power dissipation is calculated by:

$$P_{D(MAX)} = \frac{T_{J(MAX)} - T_A}{\theta_{JA}}$$

where:

- ♦ P_{D(MAX)} is the maximum power dissipation.
- ♦ T_{J(MAX)} is the maximum operating junction temperature.
- ♦ T_A is the operating ambient temperature.
- ♦ θ_{JA} is the package thermal resistance.

The maximum operating junction temperature must be restricted to +105°C under normal operating conditions. Care should be taken that the thermal vias are placed under the exposed pad of the device, thus allowing for thermal dissipation away from the device.

REVISION HISTORY

NOTE: Page numbers for previous revisions may differ from page numbers in the current version.

JUNE 2023 – REV.A.1 to REV.A.2	Page
Updated Package Outline Dimensions section	16
<hr/>	
OCTOBER 2022 – REV.A to REV.A.1	Page
Updated Absolute Maximum Ratings section.....	2
<hr/>	
Changes from Original (JUNE 2022) to REV.A	Page
Changed from product preview to production data.....	All

PACKAGE OUTLINE DIMENSIONS

TDFN-2x2-8AL

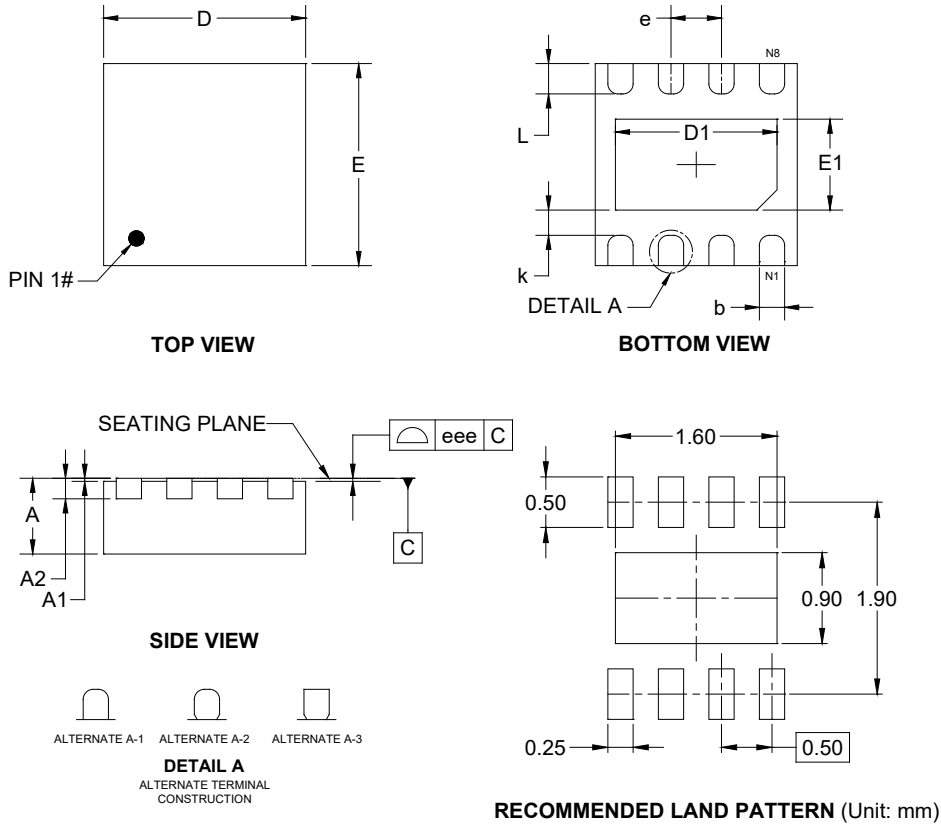

Symbol	Dimensions in Millimeters		
	MIN	MOD	MAX
A	0.700	-	0.800
A1	0.000	-	0.050
A2	0.203 REF		
b	0.200	-	0.300
D	1.900	-	2.100
D1	1.450	-	1.700
E	1.900	-	2.100
E1	0.750	-	1.000
k	0.200	-	-
e	0.500 BSC		
L	0.200	-	0.400
eee	0.080		

NOTE: This drawing is subject to change without notice.

PACKAGE INFORMATION

TAPE AND REEL INFORMATION

REEL DIMENSIONS



TAPE DIMENSIONS



NOTE: The picture is only for reference. Please make the object as the standard.

KEY PARAMETER LIST OF TAPE AND REEL

Package Type	Reel Diameter	Reel Width W1 (mm)	A0 (mm)	B0 (mm)	K0 (mm)	P0 (mm)	P1 (mm)	P2 (mm)	W (mm)	Pin1 Quadrant
TDFN-2×2-8AL	7"	9.5	2.30	2.30	1.10	4.0	4.0	2.0	8.0	Q1

000001

PACKAGE INFORMATION

CARTON BOX DIMENSIONS



NOTE: The picture is only for reference. Please make the object as the standard.

KEY PARAMETER LIST OF CARTON BOX

Reel Type	Length (mm)	Width (mm)	Height (mm)	Pizza/Carton
7" (Option)	368	227	224	8
7"	442	410	224	18

DD0002