



SGM8535/SGM8536/SGM8537/SGM8538 1.5MHz, Rail-to-Rail Output Operational Amplifiers

GENERAL DESCRIPTION

The SGM8535 (single), SGM8536 (dual), SGM8537 (single with shutdown) and SGM8538 (quad) are voltage feedback amplifiers. These devices can operate from 1.8V to 5.5V single supply, while consuming only 80 μ A quiescent current per amplifier. They provide a wide input common mode voltage range and rail-to-rail output voltage swing. This feature makes SGM8535/6/7/8 appropriate for buffering ASIC.

The SGM8535/6/7/8 offer a gain-bandwidth product of 1.5MHz and an ultra-low input bias current of 3pA. They are well suited for piezoelectric sensors, integrators and photodiode amplifiers.

The SGM8535/6/7/8 are designed into a wide range of applications, such as battery-powered instrumentation, safety monitoring, portable systems, and transducer interface circuits in low power systems.

The SGM8535 is available in Green SOT-23-5, SC70-5, SOIC-8 and MSOP-8 packages. The SGM8536 is available in Green SOIC-8 and MSOP-8 packages. The SGM8537 is available in Green SOT-23-6, SOIC-8 and MSOP-8 packages. The SGM8538 is available in Green SOIC-14 and TSSOP-14 packages. They are specified over the -40°C to +85°C temperature range.

FEATURES

- **Low Supply Current**
 - 80 μ A/Amplifier (TYP)
 - 0.1 μ A Shutdown Current for SGM8537
- **Supply Voltage Range: 1.8V to 5.5V**
- **Rail-to-Rail Output**
- **Low Input Offset Voltage: 3.4mV (MAX)**
- **Unity-Gain Stable**
- **Gain-Bandwidth Product: 1.5MHz**
- **-40°C to +85°C Operating Temperature Range**
- **Small Packaging:**
 - SGM8535 Available in Green SOT-23-5, SC70-5, SOIC-8 and MSOP-8 Packages
 - SGM8536 Available in Green SOIC-8 and MSOP-8 Packages
 - SGM8537 Available in Green SOT-23-6, SOIC-8 and MSOP-8 Packages
 - SGM8538 Available in Green SOIC-14 and TSSOP-14 Packages

APPLICATIONS

ASIC Input or Output Amplifiers
Piezoelectric Transducer Amplifiers
Battery-Powered Equipment
Portable Equipment
Sensor Interfaces
Medical Instrumentation
Mobile Communications
Audio Outputs
Smoke Detectors
Mobile Telephones
Notebook PCs
PCMCIA Cards

PACKAGE/ORDERING INFORMATION

MODEL	PACKAGE DESCRIPTION	SPECIFIED TEMPERATURE RANGE	ORDERING NUMBER	PACKAGE MARKING	PACKING OPTION
SGM8535	SOT-23-5	-40°C to +85°C	SGM8535AYN5G/TR	SB2XX	Tape and Reel, 3000
	SOT-23-5	-40°C to +85°C	SGM8535BYN5G/TR	SB3XX	Tape and Reel, 3000
	SC70-5	-40°C to +85°C	SGM8535YC5G/TR	SB4XX	Tape and Reel, 3000
	SOIC-8	-40°C to +85°C	SGM8535YS8G/TR	SGM 8535YS8 XXXXX	Tape and Reel, 2500
	MSOP-8	-40°C to +85°C	SGM8535YMS8G/TR	SGM8535 YMS8 XXXXX	Tape and Reel, 3000
SGM8536	SOIC-8	-40°C to +85°C	SGM8536YS8G/TR	SGM8536YS8 XXXXX	Tape and Reel, 2500
	MSOP-8	-40°C to +85°C	SGM8536YMS8G/TR	SGM8536 YMS8 XXXXX	Tape and Reel, 3000
SGM8537	SOT-23-6	-40°C to +85°C	SGM8537YN6G/TR	SB5XX	Tape and Reel, 3000
	SOIC-8	-40°C to +85°C	SGM8537YS8G/TR	SGM 8537YS8 XXXXX	Tape and Reel, 2500
	MSOP-8	-40°C to +85°C	SGM8537YMS8G/TR	SGM8537 YMS8 XXXXX	Tape and Reel, 3000
SGM8538	SOIC-14	-40°C to +85°C	SGM8538YS14G/TR	SGM8538YS14 XXXXX	Tape and Reel, 2500
	TSSOP-14	-40°C to +85°C	SGM8538YTS14G/TR	SGM8538 YTS14 XXXXX	Tape and Reel, 3000

MARKING INFORMATION

NOTE: XX = Date Code. XXXXX = Date Code and Vendor Code.

SOT-23-5/SC70-5/SOT-23-6

YYY X X

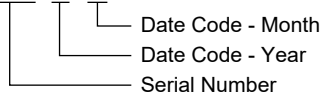

SOIC-8/MSOP-8/SOIC-14/TSSOP-14

XXXXX

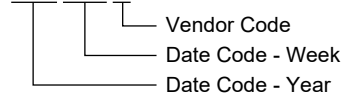

Green (RoHS & HSF): SG Micro Corp defines "Green" to mean Pb-Free (RoHS compatible) and free of halogen substances. If you have additional comments or questions, please contact your SGMICRO representative directly.

ABSOLUTE MAXIMUM RATINGS

Supply Voltage, +V _S to -V _S	6V
Input Common Mode Voltage Range.....	-0.1V to (+V _S) - 1.3V
Junction Temperature	+150°C
Storage Temperature Range.....	-65°C to +150°C
Lead Temperature (Soldering, 10s)	+260°C
ESD Susceptibility	
HBM (SGM8535/6/8)	8000V
HBM (SGM8537)	3000V
MM.....	400V

RECOMMENDED OPERATING CONDITIONS

Operating Temperature Range	-40°C to +85°C
-----------------------------------	----------------

OVERSTRESS CAUTION

Stresses beyond those listed in Absolute Maximum Ratings may cause permanent damage to the device. Exposure to absolute maximum rating conditions for extended periods may affect reliability. Functional operation of the device at any conditions beyond those indicated in the Recommended Operating Conditions section is not implied.

ESD SENSITIVITY CAUTION

This integrated circuit can be damaged if ESD protections are not considered carefully. SGMICRO recommends that all integrated circuits be handled with appropriate precautions. Failure to observe proper handling and installation procedures can cause damage. ESD damage can range from subtle performance degradation to complete device failure. Precision integrated circuits may be more susceptible to damage because even small parametric changes could cause the device not to meet the published specifications.

DISCLAIMER

SG Micro Corp reserves the right to make any change in circuit design, or specifications without prior notice.

PIN CONFIGURATIONS

**SGM8535AYN5G/TR (TOP VIEW)
SGM8535YC5G/TR (TOP VIEW)**

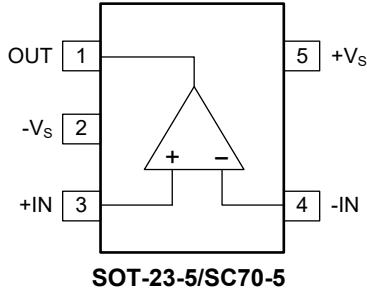

SGM8535BYN5G/TR (TOP VIEW)

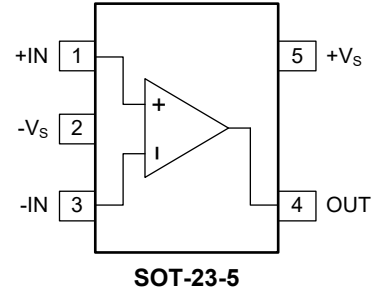

SGM8535/7 (TOP VIEW)

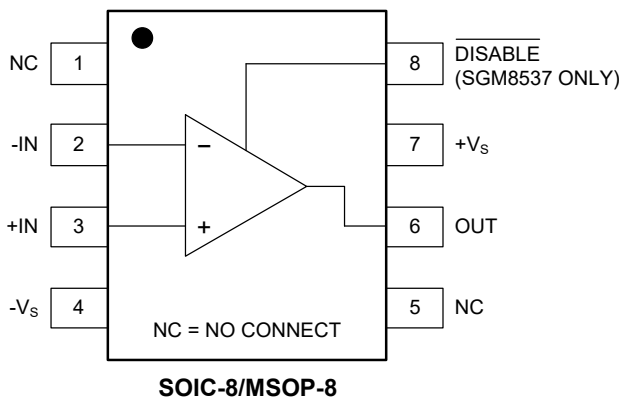

SGM8536 (TOP VIEW)

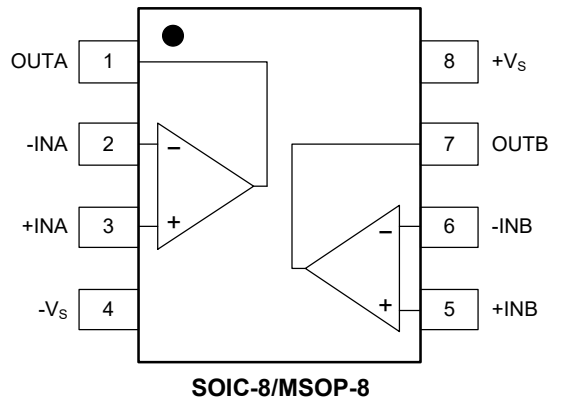

SGM8537 (TOP VIEW)

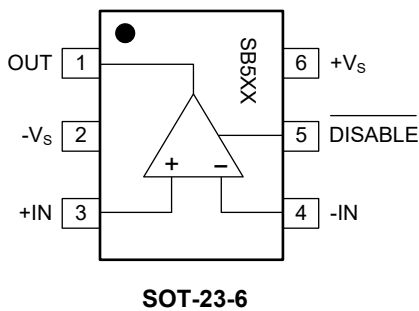

SGM8538 (TOP VIEW)

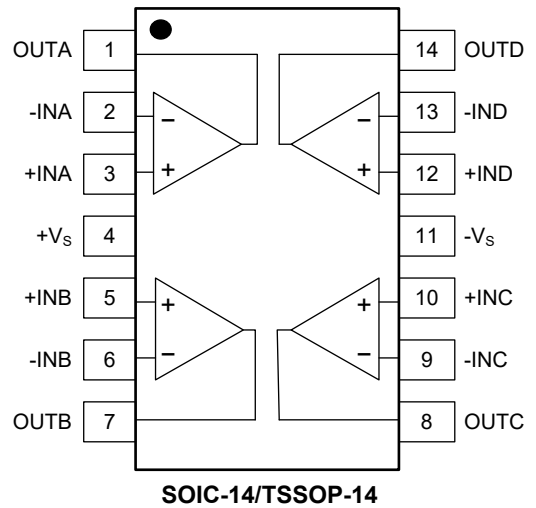

ELECTRICAL CHARACTERISTICS

($V_S = 5V$, $V_{OUT} = V_S/2$, Full = $-40^\circ C$ to $+85^\circ C$, typical values are at $T_A = +25^\circ C$, unless otherwise noted.)

PARAMETER	CONDITIONS	TEMP	MIN	TYP	MAX	UNITS
Input Characteristics						
Input Offset Voltage (V_{OS})	$V_{CM} = V_S/2$	+25°C		0.6	3.4	mV
		Full			3.8	
Input Offset Voltage Drift ($\Delta V_{OS}/\Delta T$)	$V_{CM} = V_S/2$	Full		1.5		$\mu V/^\circ C$
Input Bias Current (I_B)		+25°C		3		pA
Input Offset Current (I_{OS})		+25°C		3		pA
Input Common Mode Voltage Range (V_{CM})		Full	-0.1		3.7	V
Common Mode Rejection Ratio (CMRR)	$V_{CM} = -0.1V$ to $3.7V$	+25°C	70	85		dB
		Full	65			
Open-Loop Voltage Gain (A_{OL})	$R_L = 2k\Omega$, $V_{OUT} = 0.2V$ to $4.8V$	+25°C	80	90		dB
		Full	75			
	$R_L = 100k\Omega$, $V_{OUT} = 0.035V$ to $4.965V$	+25°C		103		
Output Characteristics						
Output Voltage Swing from Rail	$R_L = 2k\Omega$	+25°C		80	100	mV
		Full			110	
Output Short-Circuit Current (I_{SC})		+25°C	22	35		mA
		Full	18			
Power-Down (SGM8537 only)						
Logic Low Voltage (V_{IL})		+25°C			0.8	V
Logic High Voltage (V_{IH})		+25°C	2			V
Power Supply						
Quiescent Current/Amplifier (I_Q)	$I_{OUT} = 0mA$	+25°C		80	130	μA
		Full			165	
Supply Current when Disabled (SGM8537 only)		+25°C		100	1500	nA
Power Supply Rejection Ratio (PSRR)	$V_S = 1.8V$ to $5.5V$, $V_{CM} = 0.5V$	+25°C	65	80		dB
		Full	60			
Dynamic Performance						
Gain-Bandwidth Product (GBP)	$R_L = 2k\Omega$, $C_L = 100pF$	+25°C		1.5		MHz
Slew Rate (SR)	$V_{OUT} = 2V_{P-P}$, $A_V = 1$	+25°C		0.8		$V/\mu s$
Crosstalk	$f = 1kHz$	+25°C		110		dB
Settling Time to 0.1% (t_S)	$V_{OUT} = 2V_{P-P}$, $f = 1kHz$, $A_V = 1$, $R_L = 2k\Omega$, $C_L = 100pF$	+25°C		3.5		μs
Overload Recovery Time	$R_L = 2k\Omega$, $A_V = -50$	+25°C		7		μs
Noise Performance						
Input Voltage Noise Density (e_n)	$f = 1kHz$	+25°C		30		nV/\sqrt{Hz}

ELECTRICAL CHARACTERISTICS (continued)

($V_S = 1.8V$, $V_{OUT} = V_S/2$, Full = $-40^\circ C$ to $+85^\circ C$, typical values are at $T_A = +25^\circ C$, unless otherwise noted.)

PARAMETER	CONDITIONS	TEMP	MIN	TYP	MAX	UNITS
Input Characteristics						
Input Offset Voltage (V_{OS})	$V_{CM} = 0.5V$	+25°C		0.6	3.5	mV
		Full			4	
Input Offset Voltage Drift ($\Delta V_{OS}/\Delta T$)	$V_{CM} = 0.5V$	Full		1.5		$\mu V/^\circ C$
Input Bias Current (I_B)		+25°C		3		pA
Input Offset Current (I_{OS})		+25°C		3		pA
Input Common Mode Voltage Range (V_{CM})		Full	-0.1		0.5	V
Common Mode Rejection Ratio (CMRR)	$V_{CM} = -0.1V$ to $0.5V$	+25°C	64	78		dB
		Full	60			
Open-Loop Voltage Gain (A_{OL})	$R_L = 2k\Omega$, $V_{OUT} = 0.2V$ to $1.6V$	+25°C	72	82		dB
		Full	65			
	$R_L = 100k\Omega$, $V_{OUT} = 0.035V$ to $1.765V$	+25°C		100		
Output Characteristics						
Output Voltage Swing from Rail	$R_L = 2k\Omega$	+25°C		55	70	mV
		Full			100	
Output Short-Circuit Current (I_{SC})		+25°C	2.5	5		mA
		Full	2			
Power-Down (SGM8537 only)						
Logic Low Voltage (V_{IL})		+25°C			0.4	V
Logic High Voltage (V_{IH})		+25°C	1.3			V
Power Supply						
Quiescent Current/Amplifier (I_Q)	$I_{OUT} = 0mA$	+25°C		75	125	μA
		Full			160	
Supply Current when Disabled (SGM8537 only)		+25°C		10	1200	nA
Dynamic Performance						
Gain-Bandwidth Product (GBP)	$R_L = 2k\Omega$, $C_L = 100pF$	+25°C		1.3		MHz
Slew Rate (SR)	$V_{OUT} = 0.5V_{P-P}$, $A_V = 1$	+25°C		0.7		$V/\mu s$
Crosstalk	$f = 1kHz$	+25°C		110		dB
Settling Time to 0.1% (t_S)	$V_{OUT} = 0.5V_{P-P}$, $f = 1kHz$, $A_V = 1$, $R_L = 2k\Omega$, $C_L = 100pF$	+25°C		2.5		μs
Overload Recovery Time	$R_L = 2k\Omega$, $A_V = -50$	+25°C		6		μs
Noise Performance						
Input Voltage Noise Density (e_n)	$f = 1kHz$	+25°C		35		nV/\sqrt{Hz}

TYPICAL PERFORMANCE CHARACTERISTICS

At $T_A = +25^\circ\text{C}$, $V_S = 5\text{V}$, unless otherwise noted.

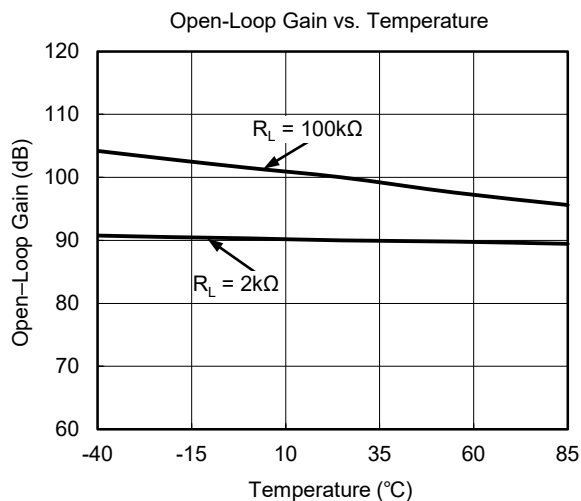
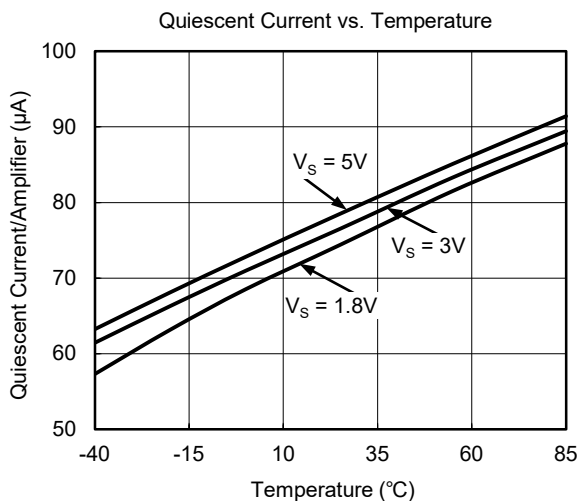
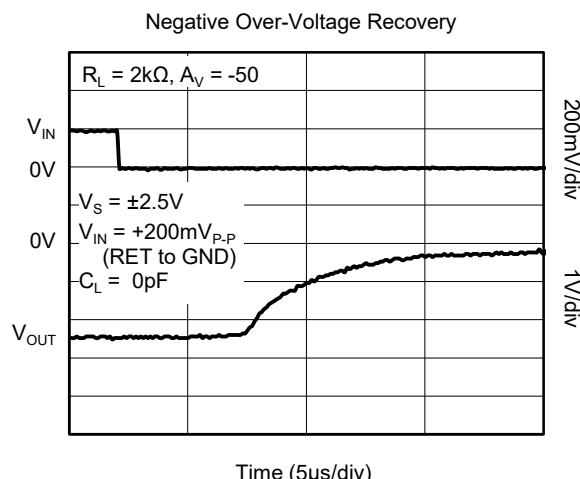
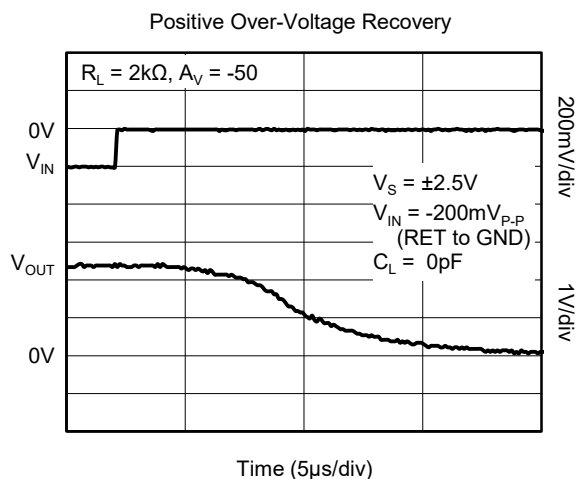
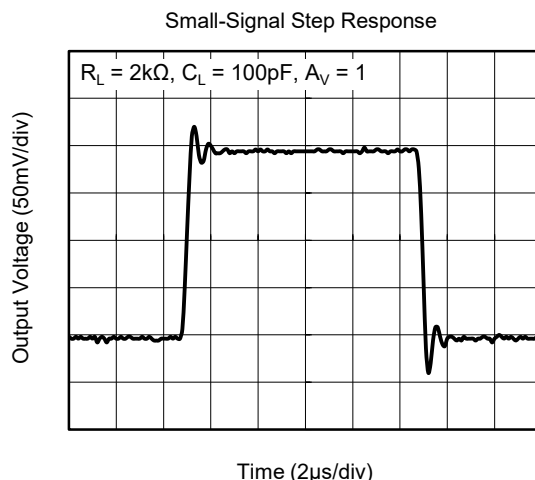
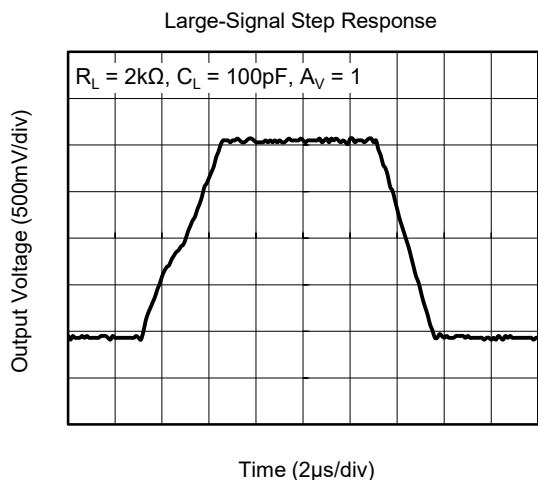

TYPICAL PERFORMANCE CHARACTERISTICS (continued)

At $T_A = +25^\circ\text{C}$, $V_S = 5\text{V}$, unless otherwise noted.

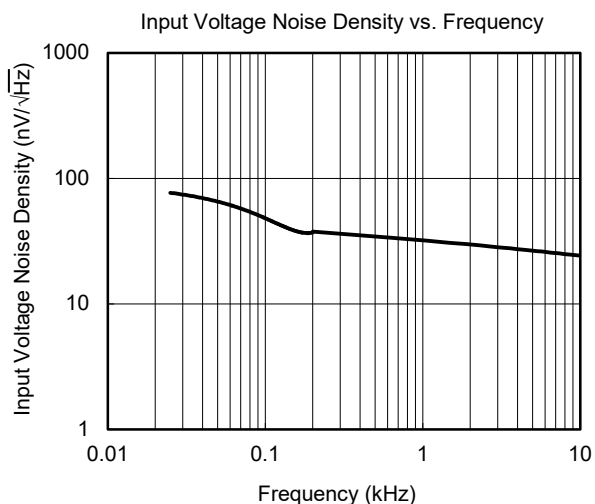
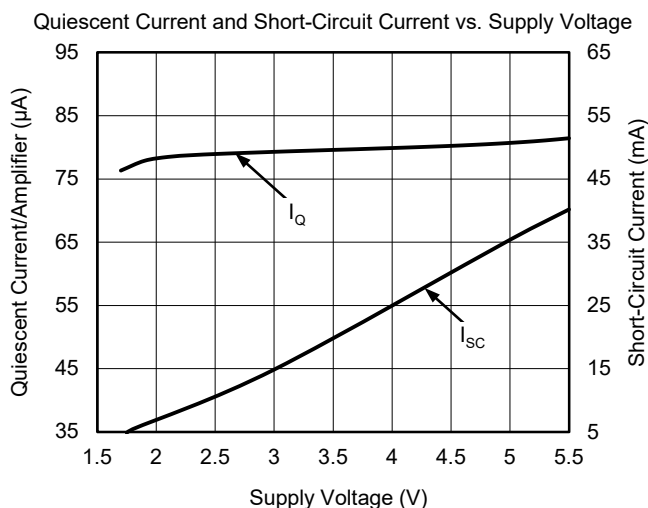
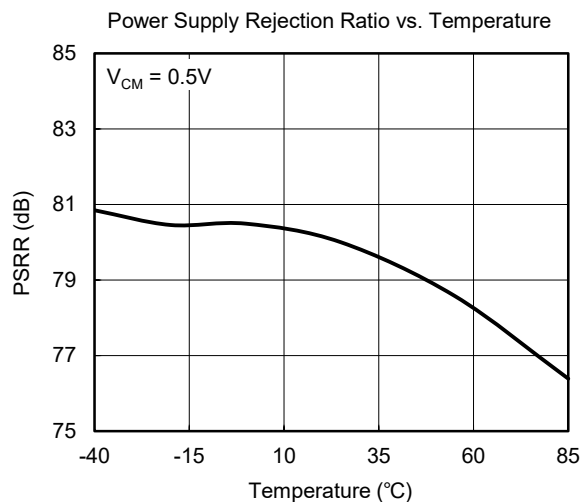
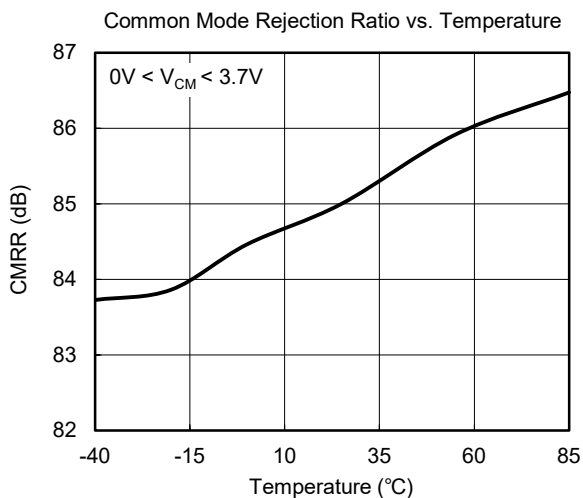

REVISION HISTORY

NOTE: Page numbers for previous revisions may differ from page numbers in the current version.

MARCH 2024 – REV.A.2 to REV.A.3	Page
Updated Package Outline Dimensions section	11

JANUARY 2013 – REV.A.1 to REV.A.2	Page
Updated Electrical Characteristics section	5, 6

JANUARY 2013 – REV.A to REV.A.1	Page
Added Tape and Reel Information section	15, 16

Changes from Original (FEBRUARY 2012) to REV.A	Page
Changed from product preview to production data.....	All

PACKAGE OUTLINE DIMENSIONS

SOT-23-5

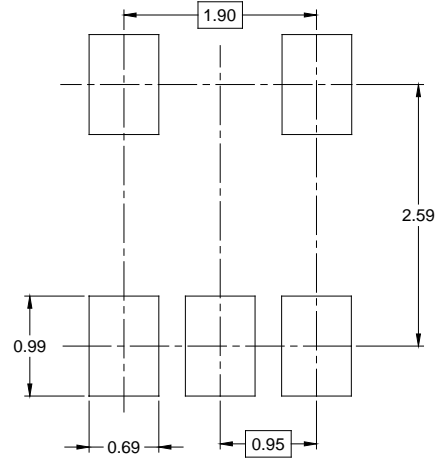
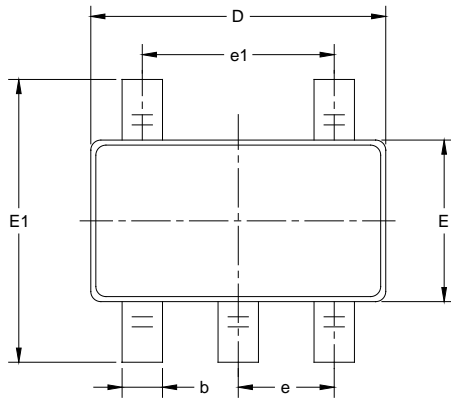

RECOMMENDED LAND PATTERN (Unit: mm)

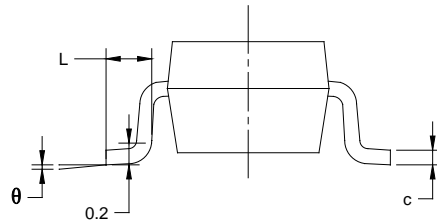
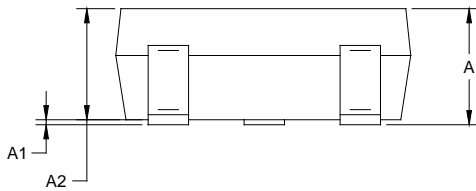

Symbol	Dimensions In Millimeters		Dimensions In Inches	
	MIN	MAX	MIN	MAX
A	1.050	1.250	0.041	0.049
A1	0.000	0.100	0.000	0.004
A2	1.050	1.150	0.041	0.045
b	0.300	0.500	0.012	0.020
c	0.100	0.200	0.004	0.008
D	2.820	3.020	0.111	0.119
E	1.500	1.700	0.059	0.067
E1	2.650	2.950	0.104	0.116
e	0.950 BSC		0.037 BSC	
e1	1.900 BSC		0.075 BSC	
L	0.300	0.600	0.012	0.024
θ	0°	8°	0°	8°

NOTES:

1. Body dimensions do not include mode flash or protrusion.
2. This drawing is subject to change without notice.

PACKAGE OUTLINE DIMENSIONS

SC70-5

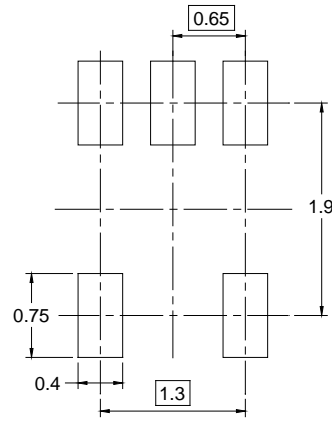
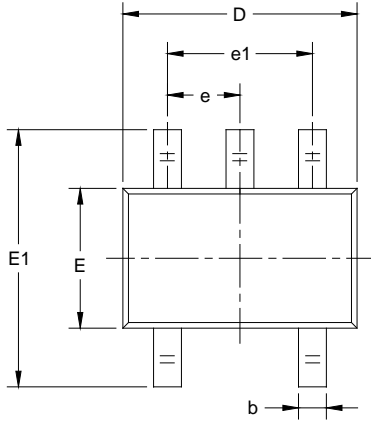

RECOMMENDED LAND PATTERN (Unit: mm)

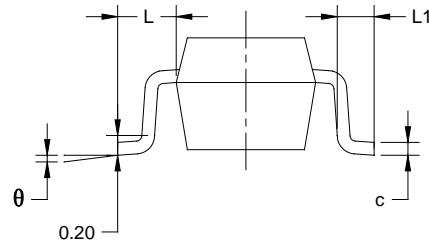
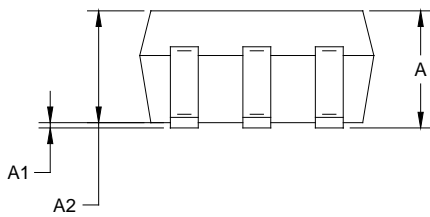

Symbol	Dimensions In Millimeters		Dimensions In Inches	
	MIN	MAX	MIN	MAX
A	0.800	1.100	0.031	0.043
A1	0.000	0.100	0.000	0.004
A2	0.800	1.000	0.031	0.039
b	0.150	0.350	0.006	0.014
c	0.080	0.220	0.003	0.009
D	2.000	2.200	0.079	0.087
E	1.150	1.350	0.045	0.053
E1	2.150	2.450	0.085	0.096
e	0.65 TYP		0.026 TYP	
e1	1.300 BSC		0.051 BSC	
L	0.525 REF		0.021 REF	
L1	0.260	0.460	0.010	0.018
θ	0°	8°	0°	8°

NOTES:

1. Body dimensions do not include mode flash or protrusion.
2. This drawing is subject to change without notice.

PACKAGE OUTLINE DIMENSIONS

SOT-23-6

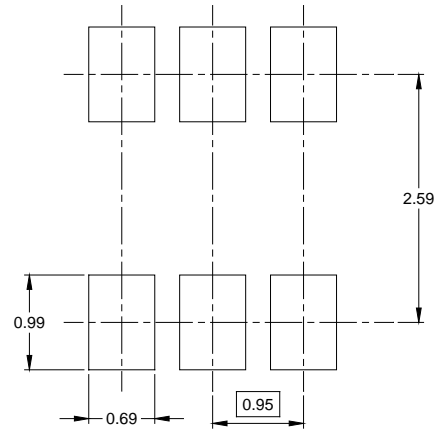
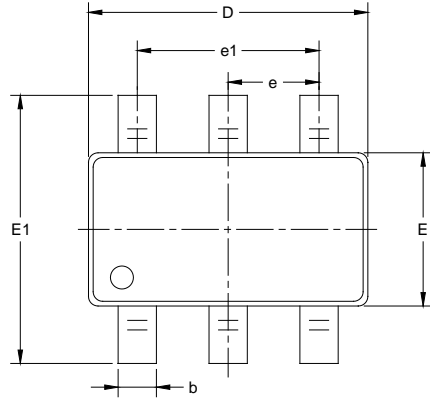

RECOMMENDED LAND PATTERN (Unit: mm)

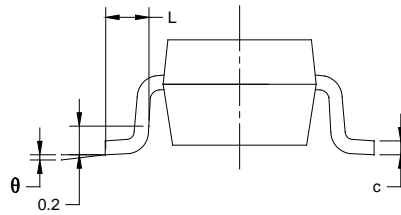
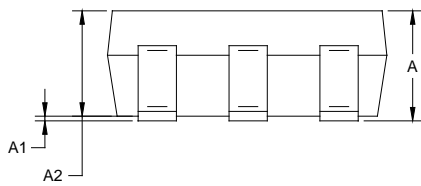

Symbol	Dimensions In Millimeters		Dimensions In Inches	
	MIN	MAX	MIN	MAX
A	1.050	1.250	0.041	0.049
A1	0.000	0.100	0.000	0.004
A2	1.050	1.150	0.041	0.045
b	0.300	0.500	0.012	0.020
c	0.100	0.200	0.004	0.008
D	2.820	3.020	0.111	0.119
E	1.500	1.700	0.059	0.067
E1	2.650	2.950	0.104	0.116
e	0.950 BSC		0.037 BSC	
e1	1.900 BSC		0.075 BSC	
L	0.300	0.600	0.012	0.024
θ	0°	8°	0°	8°

NOTES:

1. Body dimensions do not include mode flash or protrusion.
2. This drawing is subject to change without notice.

PACKAGE OUTLINE DIMENSIONS

SOIC-8

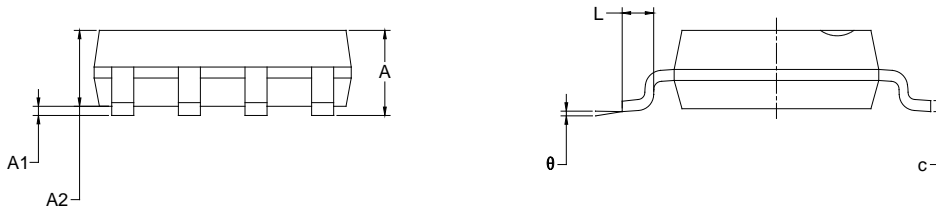
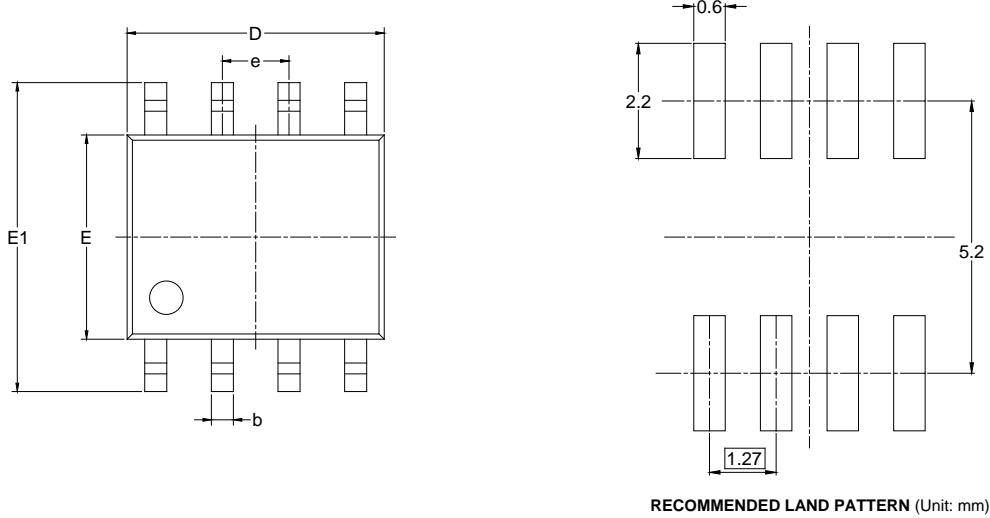

Symbol	Dimensions In Millimeters		Dimensions In Inches	
	MIN	MAX	MIN	MAX
A	1.350	1.750	0.053	0.069
A1	0.100	0.250	0.004	0.010
A2	1.350	1.550	0.053	0.061
b	0.330	0.510	0.013	0.020
c	0.170	0.250	0.006	0.010
D	4.700	5.100	0.185	0.200
E	3.800	4.000	0.150	0.157
E1	5.800	6.200	0.228	0.244
e	1.27 BSC		0.050 BSC	
L	0.400	1.270	0.016	0.050
θ	0°	8°	0°	8°

NOTES:
 1. Body dimensions do not include mode flash or protrusion.
 2. This drawing is subject to change without notice.

PACKAGE OUTLINE DIMENSIONS

MSOP-8

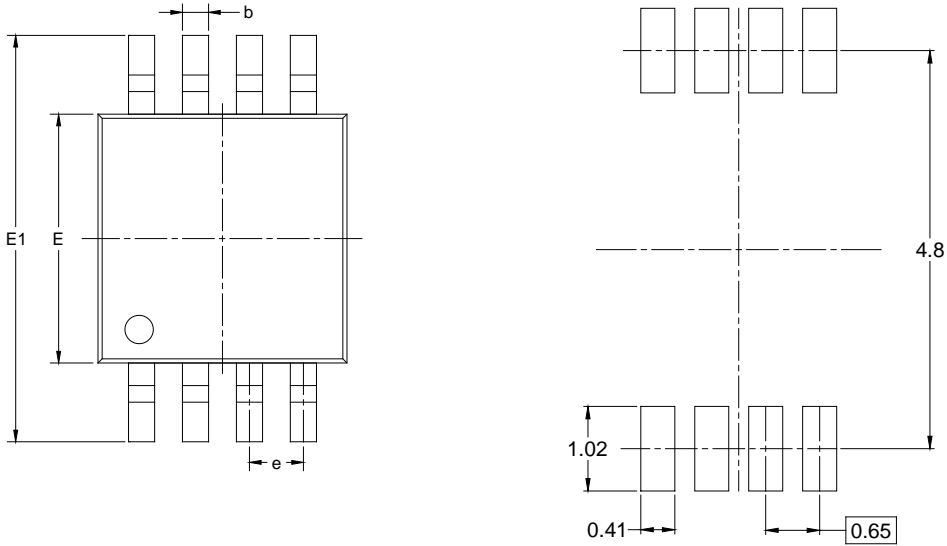

RECOMMENDED LAND PATTERN (Unit: mm)

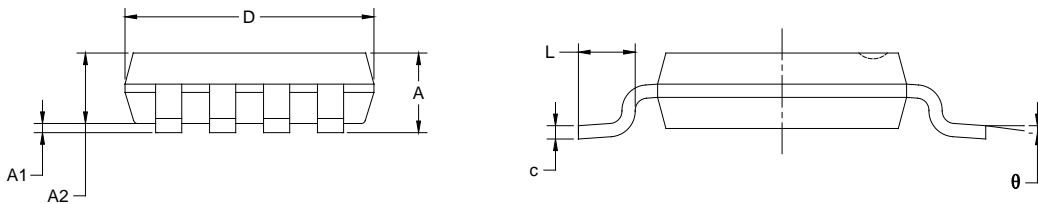

Symbol	Dimensions In Millimeters		Dimensions In Inches	
	MIN	MAX	MIN	MAX
A	0.820	1.100	0.032	0.043
A1	0.020	0.150	0.001	0.006
A2	0.750	0.950	0.030	0.037
b	0.250	0.380	0.010	0.015
c	0.090	0.230	0.004	0.009
D	2.900	3.100	0.114	0.122
E	2.900	3.100	0.114	0.122
E1	4.750	5.050	0.187	0.199
e	0.650 BSC		0.026 BSC	
L	0.400	0.800	0.016	0.031
θ	0°	6°	0°	6°

NOTES:

1. Body dimensions do not include mode flash or protrusion.
2. This drawing is subject to change without notice.

PACKAGE OUTLINE DIMENSIONS

SOIC-14

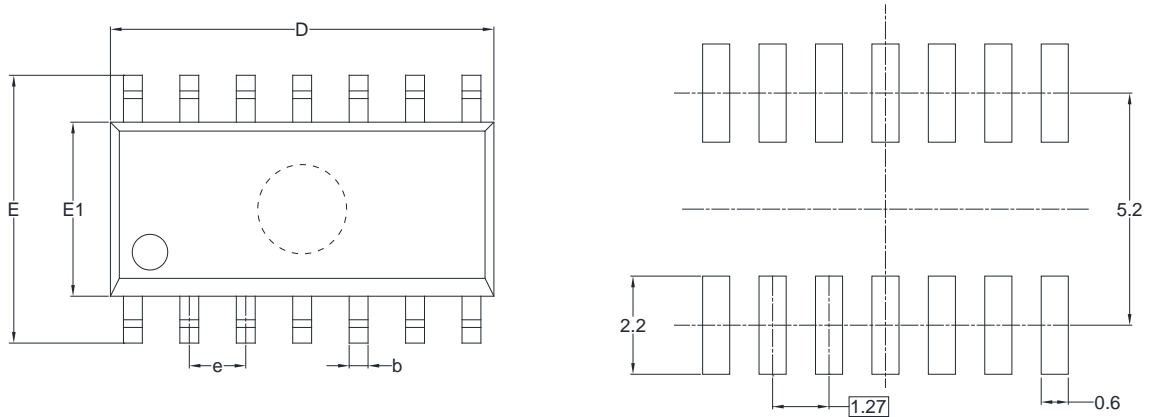

RECOMMENDED LAND PATTERN (Unit: mm)

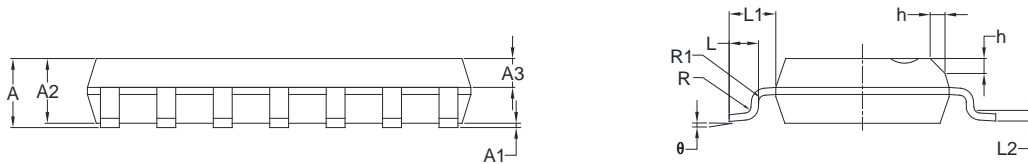

Symbol	Dimensions In Millimeters		Dimensions In Inches	
	MIN	MAX	MIN	MAX
A	1.35	1.75	0.053	0.069
A1	0.10	0.25	0.004	0.010
A2	1.25	1.65	0.049	0.065
A3	0.55	0.75	0.022	0.030
b	0.36	0.49	0.014	0.019
D	8.53	8.73	0.336	0.344
E	5.80	6.20	0.228	0.244
E1	3.80	4.00	0.150	0.157
e	1.27 BSC		0.050 BSC	
L	0.45	0.80	0.018	0.032
L1	1.04 REF		0.040 REF	
L2	0.25 BSC		0.01 BSC	
R	0.07		0.003	
R1	0.07		0.003	
h	0.30	0.50	0.012	0.020
θ	0°	8°	0°	8°

NOTES:

1. Body dimensions do not include mode flash or protrusion.
2. This drawing is subject to change without notice.

PACKAGE OUTLINE DIMENSIONS

TSSOP-14

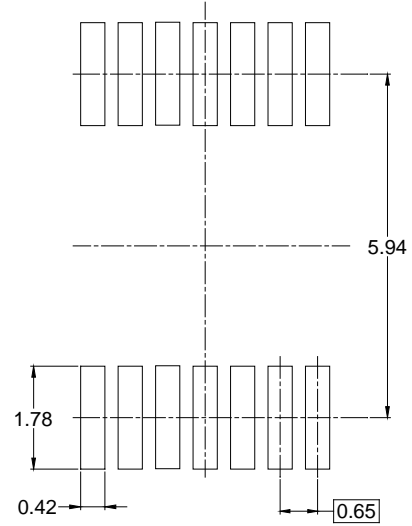
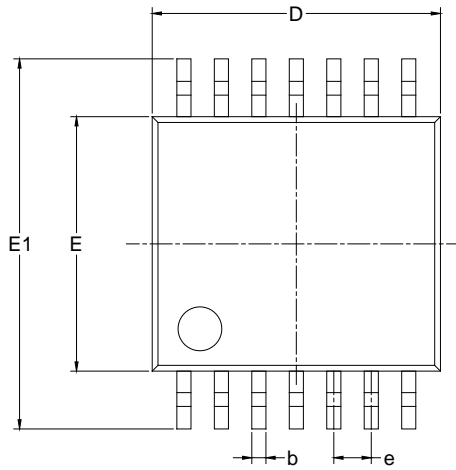

RECOMMENDED LAND PATTERN (Unit: mm)

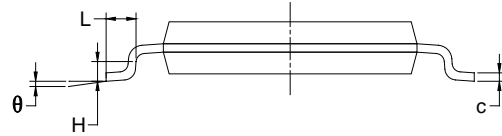
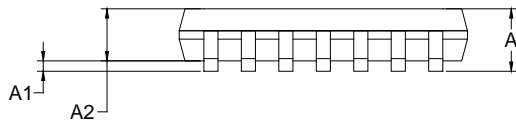

Symbol	Dimensions In Millimeters		Dimensions In Inches	
	MIN	MAX	MIN	MAX
A		1.200		0.047
A1	0.050	0.150	0.002	0.006
A2	0.800	1.050	0.031	0.041
b	0.190	0.300	0.007	0.012
c	0.090	0.200	0.004	0.008
D	4.860	5.100	0.191	0.201
E	4.300	4.500	0.169	0.177
E1	6.250	6.550	0.246	0.258
e	0.650 BSC		0.026 BSC	
L	0.500	0.700	0.02	0.028
H	0.25 TYP		0.01 TYP	
θ	1°	7°	1°	7°

NOTES:

1. Body dimensions do not include mode flash or protrusion.
2. This drawing is subject to change without notice.

PACKAGE INFORMATION

TAPE AND REEL INFORMATION

REEL DIMENSIONS

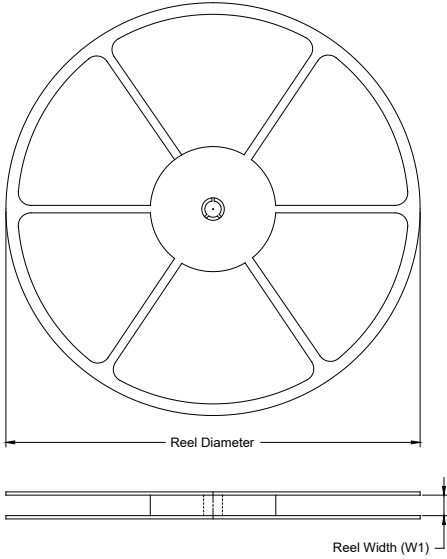

TAPE DIMENSIONS



NOTE: The picture is only for reference. Please make the object as the standard.

KEY PARAMETER LIST OF TAPE AND REEL

Package Type	Reel Diameter	Reel Width W1 (mm)	A0 (mm)	B0 (mm)	K0 (mm)	P0 (mm)	P1 (mm)	P2 (mm)	W (mm)	Pin1 Quadrant
SOT-23-5	7"	9.5	3.20	3.20	1.40	4.0	4.0	2.0	8.0	Q3
SC70-5	7"	9.5	2.40	2.50	1.20	4.0	4.0	2.0	8.0	Q3
SOT-23-6	7"	9.5	3.23	3.17	1.37	4.0	4.0	2.0	8.0	Q3
SOIC-8	13"	12.4	6.40	5.40	2.10	4.0	8.0	2.0	12.0	Q1
MSOP-8	13"	12.4	5.20	3.30	1.50	4.0	8.0	2.0	12.0	Q1
SOIC-14	13"	16.4	6.60	9.30	2.10	4.0	8.0	2.0	16.0	Q1
TSSOP-14	13"	12.4	6.40	5.40	1.50	4.0	8.0	2.0	12.0	Q1

D00001

PACKAGE INFORMATION

CARTON BOX DIMENSIONS



NOTE: The picture is only for reference. Please make the object as the standard.

KEY PARAMETER LIST OF CARTON BOX

Reel Type	Length (mm)	Width (mm)	Height (mm)	Pizza/Carton
7" (Option)	368	227	224	8
7"	442	410	224	18
13"	386	280	370	5

DD0002