



# SGM8091/SGM8092 SGM8093/SGM8094 350MHz, Rail-to-Rail Output CMOS Operational Amplifiers

## GENERAL DESCRIPTION

The SGM8091/3 (single), SGM8092 (dual) and SGM8094 (quad) are high speed operational amplifiers, which can operate from 2.5V to 5.5V single supply. The SGM8091/2/3/4 feature an 8mV maximum input offset voltage and offer a low supply current of 4.3mA/amplifier.

The SGM8091/2/3/4 have excellent performance. They have a bandwidth and slew rate usually exist in current feedback amplifiers. They exhibit a wide bandwidth of 350MHz (G=+1) and a 0.1dB gain flatness of 70MHz (G=+1).

The SGM8091/2/3/4 provide wide input common mode voltage range and rail-to-rail output swing. The fast settling time and low distortion make the operational amplifiers appropriate for high speed ADC/DAC. The supply current of SGM8093 is 75 $\mu$ A in shutdown mode. The devices are suitable for use in portable instrumentation and battery-powered systems. They are specified over the extended -40 $^{\circ}$ C to +125 $^{\circ}$ C temperature range.

## APPLICATIONS

ADC  
DVD  
Filter  
Hand Set  
Imaging  
Base Station  
Photodiode Preamp

## FEATURES

- **High Speed:**
  - 3dB Bandwidth (G = +1): 350MHz
  - Slew Rate: 265V/ $\mu$ s
  - Settling Time to 0.1% with 2V Step: 32ns
- **Excellent Video Performance ( $R_L = 150\Omega$ , G = +2):**
  - 0.1dB Gain Flatness: 70MHz
  - Diff Gain: 0.004%, Diff Phase: 0.08 $^{\circ}$
- **Input Offset Voltage: 8mV (MAX)**
- **Rail-to-Rail Output**
- **Supply Voltage Range: 2.5V to 5.5V**
- **Input Common Mode Voltage Range:**
  - 0.2V to 3.8V with  $V_S = 5V$
- **Low Supply Current:**
  - 4.3mA/Amplifier (TYP)
  - 75 $\mu$ A Shutdown Current for SGM8093
- **-40 $^{\circ}$ C to +125 $^{\circ}$ C Operating Temperature Range**
- **Small Packaging:**
  - SGM8091 Available in Green SOIC-8 and SOT-23-5 Packages
  - SGM8092 Available in Green SOIC-8 and MSOP-8 Packages
  - SGM8093 Available in Green SOIC-8 and SOT-23-6 Packages
  - SGM8094 Available in Green SOIC-14 and TSSOP-14 Packages

**PACKAGE/ORDERING INFORMATION**

MODEL	PACKAGE DESCRIPTION	SPECIFIED TEMPERATURE RANGE	ORDERING NUMBER	PACKAGE MARKING	PACKING OPTION
SGM8091	SOT-23-5	-40°C to +125°C	SGM8091XN5/TR	8091	Tape and Reel, 3000
	SOIC-8	-40°C to +125°C	SGM8091XS/TR	SGM8091XS XXXXX	Tape and Reel, 2500
SGM8092	SOIC-8	-40°C to +125°C	SGM8092XS/TR	SGM8092XS XXXXX	Tape and Reel, 2500
	MSOP-8	-40°C to +125°C	SGM8092XMS/TR	SGM8092 XMS XXXXX	Tape and Reel, 3000
SGM8093	SOT-23-6	-40°C to +125°C	SGM8093XN6/TR	8093	Tape and Reel, 3000
	SOIC-8	-40°C to +125°C	SGM8093XS/TR	SGM8093XS XXXXX	Tape and Reel, 2500
SGM8094	SOIC-14	-40°C to +125°C	SGM8094XS14/TR	SGM8094XS14 XXXXX	Tape and Reel, 2500
	TSSOP-14	-40°C to +125°C	SGM8094XTS14/TR	SGM8094 XTS14 XXXXX	Tape and Reel, 3000

**MARKING INFORMATION**

NOTE: XXXXX = Date Code and Vendor Code.

**SOIC-8/MSOP-8/SOIC-14/TSSOP-14**

**XXXXX**

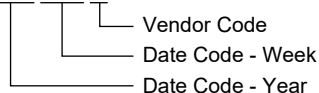

Green (RoHS & HSF): SG Micro Corp defines "Green" to mean Pb-Free (RoHS compatible) and free of halogen substances. If you have additional comments or questions, please contact your SGMICRO representative directly.

**ABSOLUTE MAXIMUM RATINGS**

Supply Voltage, +Vs to -Vs .....	7.5V
Input Common Mode Voltage Range .....	(-Vs) - 0.5V to (+Vs) + 0.5V
Package Thermal Resistance @ TA = +25°C .....	
SOT-23-5, $\theta_{JA}$ .....	190°C/W
SOT-23-6, $\theta_{JA}$ .....	190°C/W
SOIC-8, $\theta_{JA}$ .....	125°C/W
MSOP-8, $\theta_{JA}$ .....	216°C/W
Junction Temperature .....	+150°C
Storage Temperature Range .....	-65°C to +150°C
Lead Temperature (Soldering, 10s) .....	+260°C
ESD Susceptibility .....	
HBM .....	1000V
MM .....	400V

**RECOMMENDED OPERATING CONDITIONS**

Operating Temperature Range .....	-40°C to +125°C
-----------------------------------	-----------------

**OVERSTRESS CAUTION**

Stresses beyond those listed in Absolute Maximum Ratings may cause permanent damage to the device. Exposure to absolute maximum rating conditions for extended periods may affect reliability. Functional operation of the device at any conditions beyond those indicated in the Recommended Operating Conditions section is not implied.

**ESD SENSITIVITY CAUTION**

This integrated circuit can be damaged if ESD protections are not considered carefully. SGMICRO recommends that all integrated circuits be handled with appropriate precautions. Failure to observe proper handling and installation procedures can cause damage. ESD damage can range from subtle performance degradation to complete device failure. Precision integrated circuits may be more susceptible to damage because even small parametric changes could cause the device not to meet the published specifications.

**DISCLAIMER**

SG Micro Corp reserves the right to make any change in circuit design, or specifications without prior notice.

**PIN CONFIGURATIONS**

**SGM8091 (TOP VIEW)**

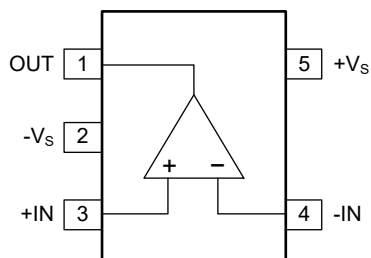

**SOT-23-5**

**SGM8093 (TOP VIEW)**

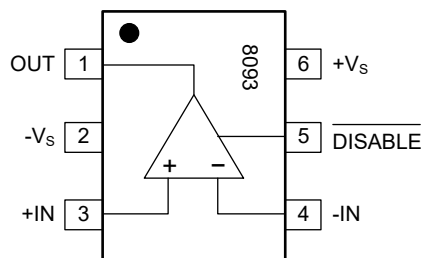

**SOT-23-6**

**SGM8092 (TOP VIEW)**

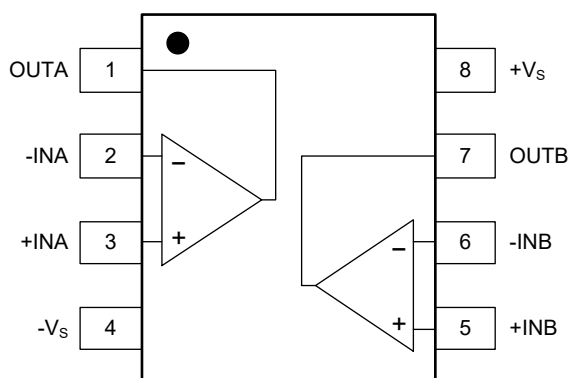

**SOIC-8/MSOP-8**

**SGM8091/8093 (TOP VIEW)**

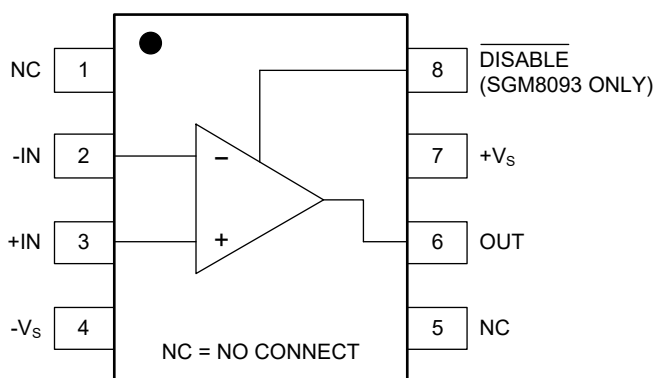

**SOIC-8**

**SGM8094 (TOP VIEW)**

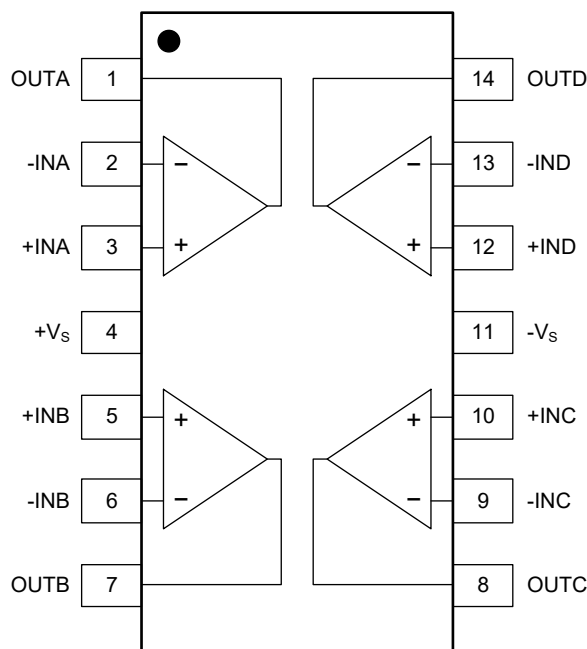

**SOIC-14/TSSOP-14**

**ELECTRICAL CHARACTERISTICS**

( $V_S = 5V$ ,  $G = +2$ ,  $R_F = 600\Omega$ ,  $R_L = 150\Omega$ , unless otherwise noted.)

PARAMETER	CONDITIONS	SGM8091/2/3/4						UNITS	MIN/ MAX
		TYP	MIN/MAX OVER TEMPERATURE						
		+25°C	+25°C	0°C to +70°C	-40°C to +70°C	-40°C to +125°C			
<b>Dynamic Performance</b>									
-3dB Small Signal Bandwidth	$G = +1, V_O = 0.1V_{P-P}, R_F = 24\Omega, R_L = 150\Omega$	300					MHz	TYP	
	$G = +1, V_O = 0.1V_{P-P}, R_F = 24\Omega, R_L = 1k\Omega$	350					MHz	TYP	
	$G = +2, V_O = 0.1V_{P-P}, R_L = 50\Omega$	70					MHz	TYP	
	$G = +2, V_O = 0.1V_{P-P}, R_L = 150\Omega$	140					MHz	TYP	
	$G = +2, V_O = 0.1V_{P-P}, R_L = 1k\Omega$	170					MHz	TYP	
	$G = +2, V_O = 0.1V_{P-P}, R_L = 10k\Omega$	230					MHz	TYP	
Gain-Bandwidth Product	$G = +10, R_L = 150\Omega$	135					MHz	TYP	
	$G = +10, R_L = 1k\Omega$	170					MHz	TYP	
Bandwidth for 0.1dB Flatness	$G = +1, V_O = 0.1V_{P-P}$	125					MHz	TYP	
	$G = +2, V_O = 0.1V_{P-P}, R_F = 600\Omega$	70					MHz	TYP	
Slew Rate	$G = +1, 2V$ output step	194/-204					V/ $\mu$ s	TYP	
	$G = +2, 2V$ output step	236/-170					V/ $\mu$ s	TYP	
	$G = +2, 4V$ output step	265/-218					V/ $\mu$ s	TYP	
Rise-and-Fall Time	$G = +2, V_O = 0.2V_{P-P}, 10\%$ to 90%	3.8					ns	TYP	
	$G = +2, V_O = 2V_{P-P}, 10\%$ to 90%	7.8					ns	TYP	
Settling Time to 0.1%	$G = +2, 2V$ output step	32					ns	TYP	
Overload Recovery Time	$V_{IN} \cdot G = +V_S$	14.5					ns	TYP	
<b>Noise/Distortion Performance</b>									
Input Voltage Noise	$f = 1MHz$	5.9					nV/ $\sqrt{Hz}$	TYP	
Differential Gain Error (NTSC)	$G = +2, R_L = 150\Omega$	0.004					%	TYP	
Differential Phase Error (NTSC)	$G = +2, R_L = 150\Omega$	0.08					degree	TYP	
<b>DC Performance</b>									
Input Offset Voltage ( $V_{OS}$ )		$\pm 2$	$\pm 8$	$\pm 8.9$	$\pm 9.5$	$\pm 9.8$	mV	MAX	
Input Offset Voltage Drift		3.7					$\mu V/^\circ C$	TYP	
Input Bias Current ( $I_B$ )		6					PA	TYP	
Input offset Current ( $I_{OS}$ )		2					PA	TYP	
Open-Loop Gain ( $A_{OL}$ )	$V_O = 0.3V$ to $4.7V, R_L = 150\Omega$	80	75	74	74	73	dB	MIN	
	$V_O = 0.2V$ to $4.8V, R_L = 1k\Omega$	104	92	91	91	80	dB	MIN	
<b>Input Characteristics</b>									
Input Common Mode Voltage Range ( $V_{CM}$ )		-0.2 to +3.8					V	TYP	
Common Mode Rejection Ratio (CMRR)	$V_{CM} = -0.1V$ to $3.5V$	80	66	66	65	64	dB	MIN	
<b>Output Characteristics</b>									
Output Voltage Swing from Rail	$R_L = 150\Omega$	0.12					V	TYP	
	$R_L = 1k\Omega$	0.03					V	TYP	
Output Current		115	98	97	94	88	mA	MIN	
Closed-Loop Output Impedance	$f < 100kHz$	0.02					$\Omega$	TYP	
<b>Power-Down Disable</b>									
Turn-On Time		108					ns	TYP	
Turn-Off Time		60					ns	TYP	
$\overline{DISABLE}$ Voltage-Off			0.8				V	MAX	
$\overline{DISABLE}$ Voltage-On			2				V	MIN	
<b>Power Supply</b>									
Operating Voltage Range			2.5	2.7	2.7	2.7	V	MIN	
			5.5	5.5	5.5	5.5	V	MAX	
Quiescent Current (per Amplifier)		4.3	7.5	8.0	8.0	8.1	mA	MAX	
Supply Current when Disabled (SGM8093 only)		75	120	127	130	137	$\mu A$	MAX	
Power Supply Rejection Ratio (PSRR)	$\Delta V_S = 2.7V$ to $5.5V, V_{CM} = (-V_S) + 0.5$	80	66	66	64	62	dB	MIN	

**TYPICAL PERFORMANCE CHARACTERISTICS**

At  $T_A = +25^\circ\text{C}$ ,  $V_S = 5\text{V}$ ,  $G = +2$ ,  $R_F = 600\Omega$ ,  $R_G = 600\Omega$ , and  $R_L = 150\Omega$  connected to  $V_S/2$ , unless otherwise noted.

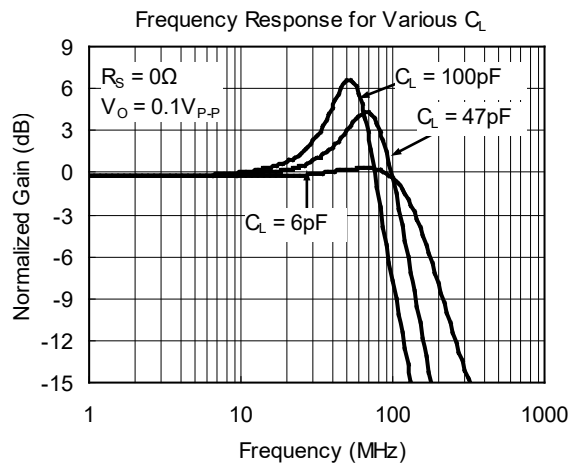
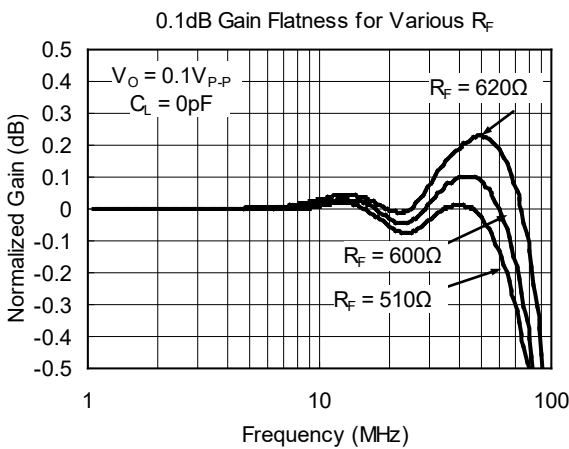
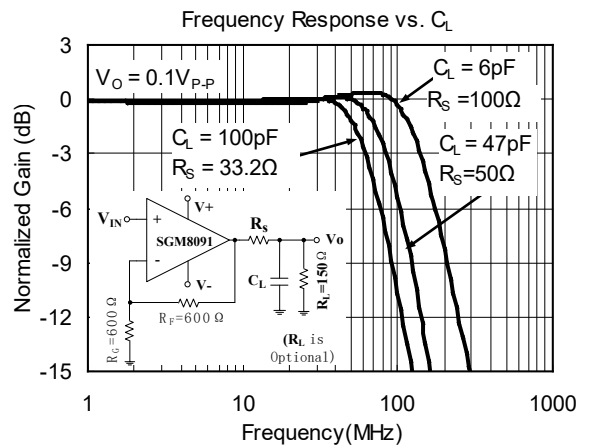
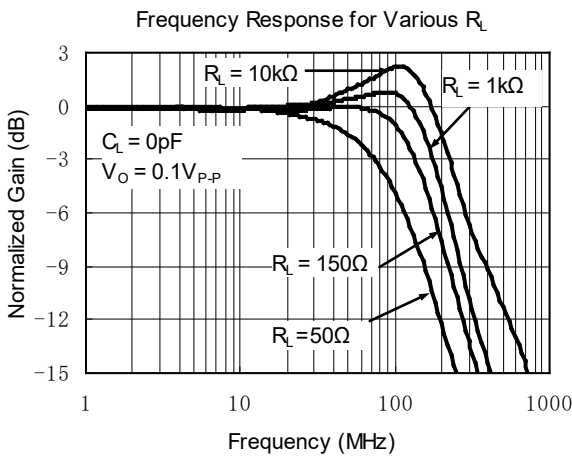
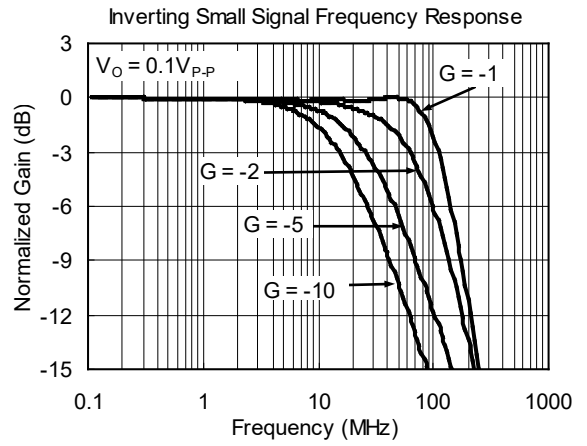
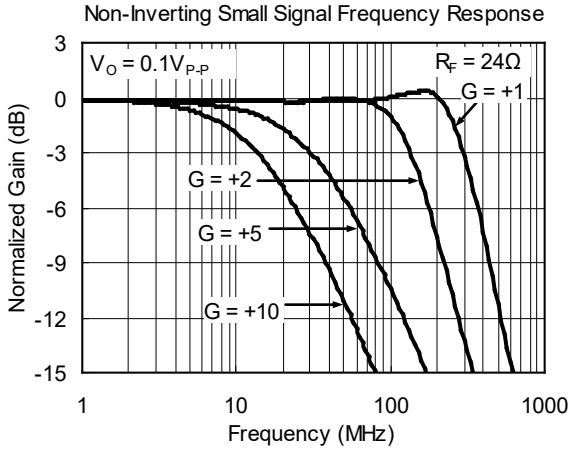

**TYPICAL PERFORMANCE CHARACTERISTICS (continued)**

At  $T_A = +25^\circ\text{C}$ ,  $V_S = 5\text{V}$ ,  $G = +2$ ,  $R_F = 600\Omega$ ,  $R_G = 600\Omega$ , and  $R_L = 150\Omega$  connected to  $V_S/2$ , unless otherwise noted.

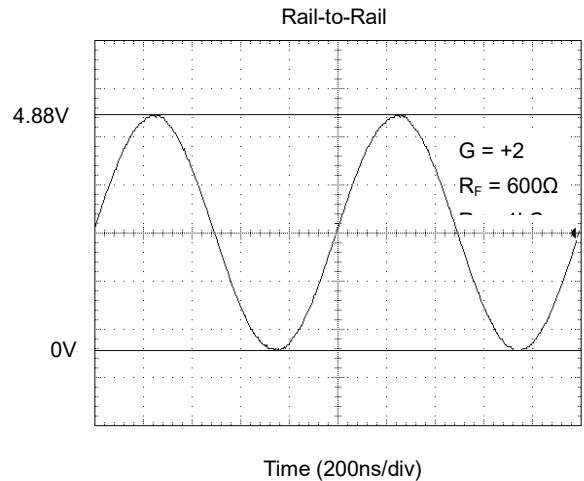
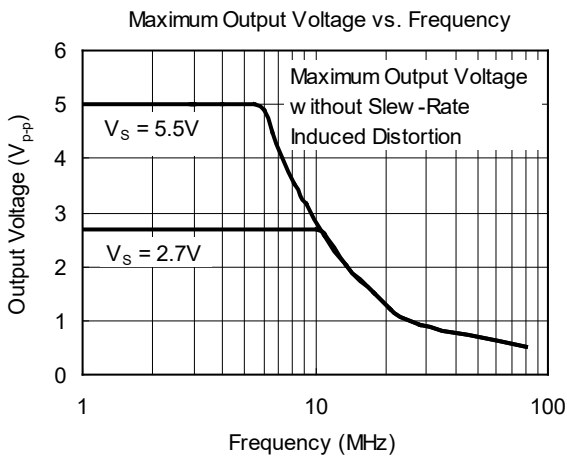
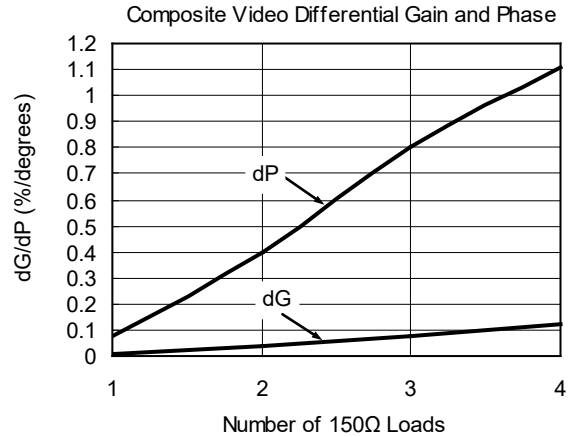
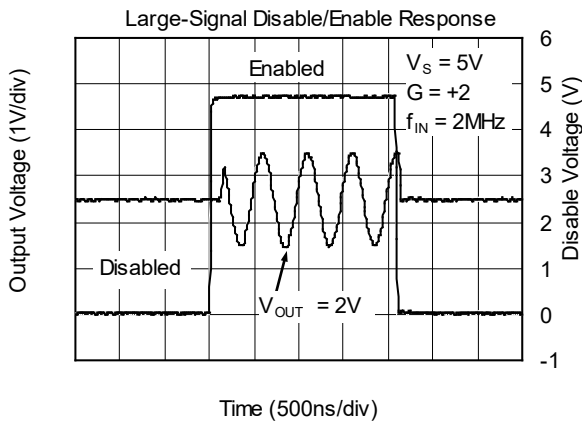
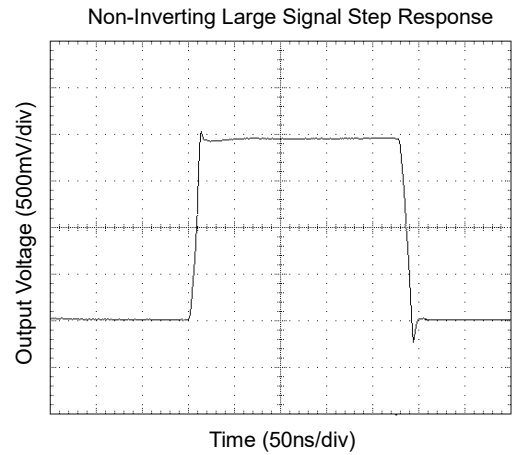
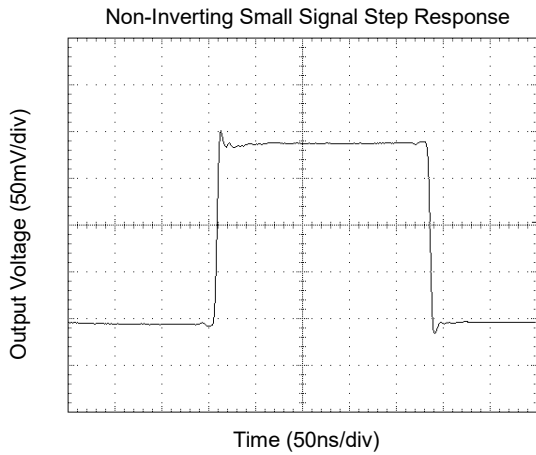

**TYPICAL PERFORMANCE CHARACTERISTICS (continued)**

At  $T_A = +25^\circ\text{C}$ ,  $V_S = 5\text{V}$ ,  $G = +2$ ,  $R_F = 600\Omega$ ,  $R_G = 600\Omega$ , and  $R_L = 150\Omega$  connected to  $V_S/2$ , unless otherwise noted.

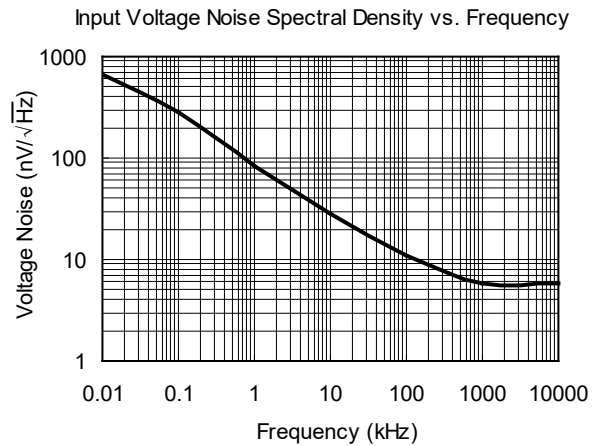
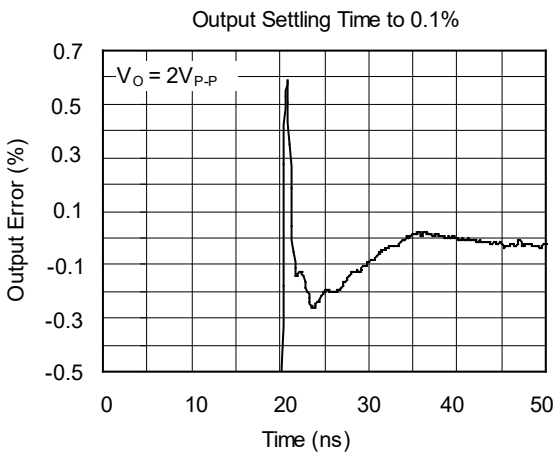
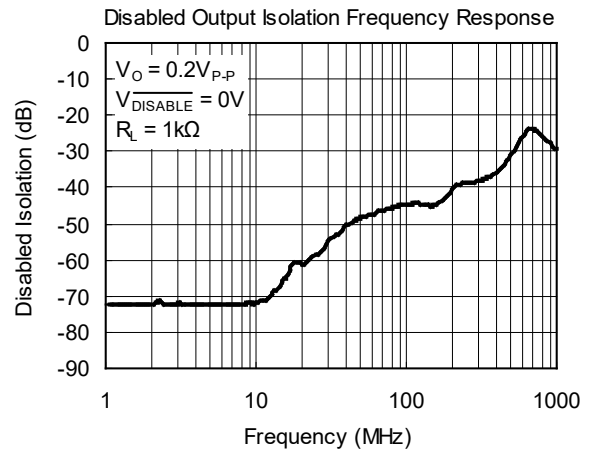
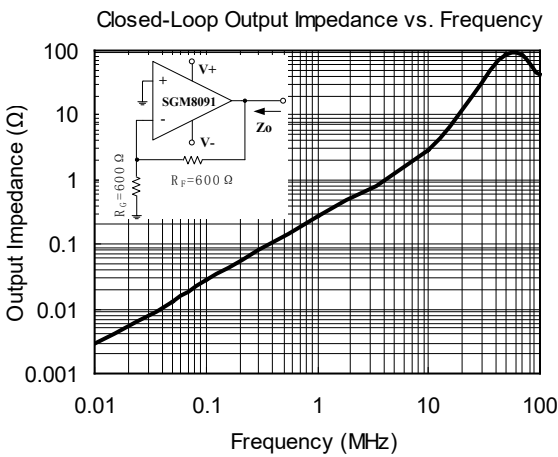
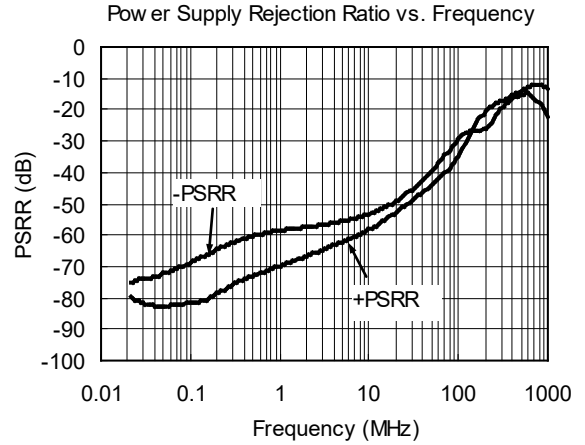
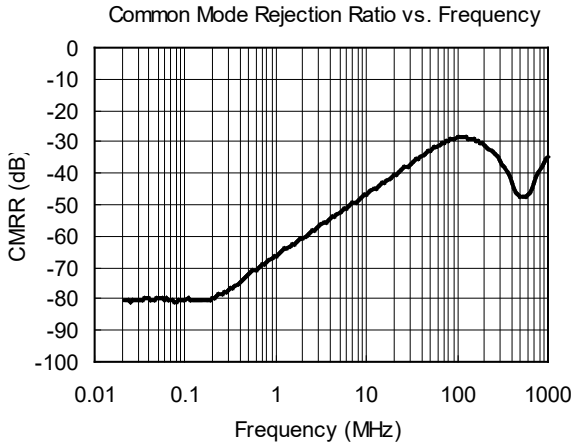



**TYPICAL PERFORMANCE CHARACTERISTICS (continued)**

At  $T_A = +25^\circ\text{C}$ ,  $V_S = 5\text{V}$ ,  $G = +2$ ,  $R_F = 600\Omega$ ,  $R_G = 600\Omega$ , and  $R_L = 150\Omega$  connected to  $V_S/2$ , unless otherwise noted.

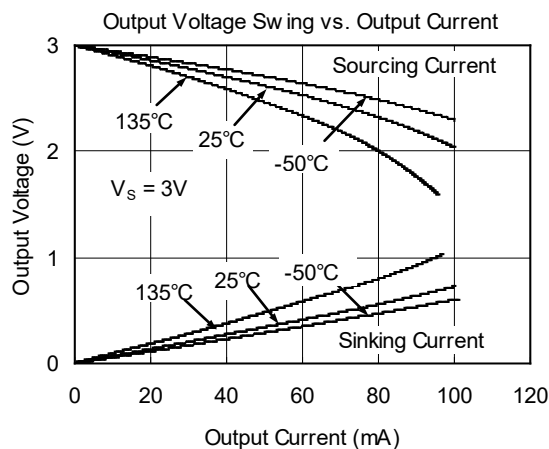
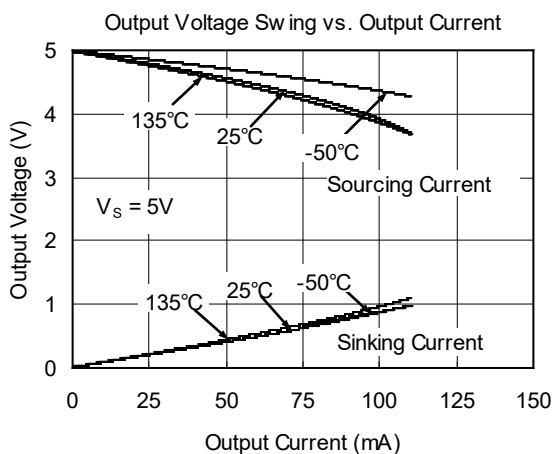
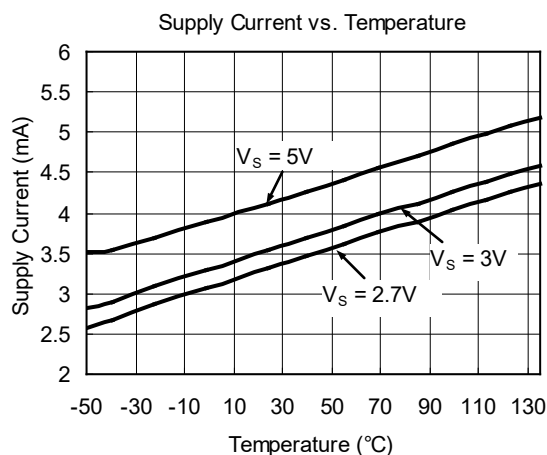
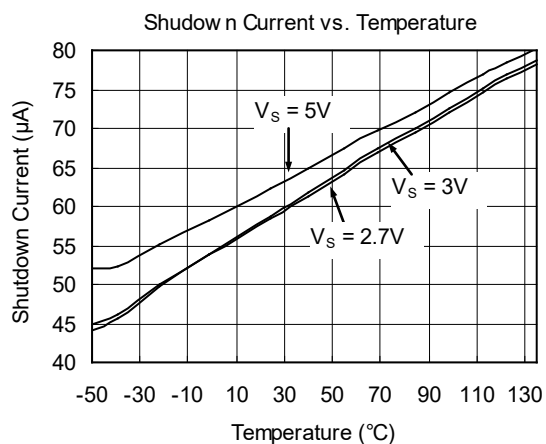
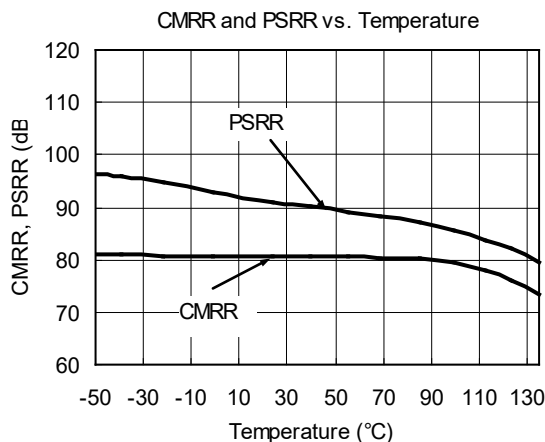
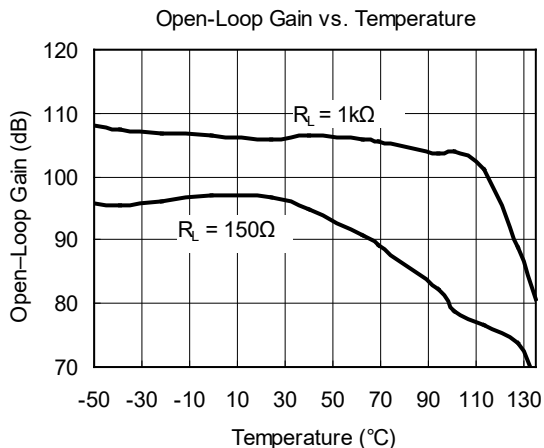

**TYPICAL PERFORMANCE CHARACTERISTICS (continued)**

At  $T_A = +25^\circ\text{C}$ ,  $V_S = 5\text{V}$ ,  $G = +2$ ,  $R_F = 600\Omega$ ,  $R_G = 600\Omega$ , and  $R_L = 150\Omega$  connected to  $V_S/2$ , unless otherwise noted.

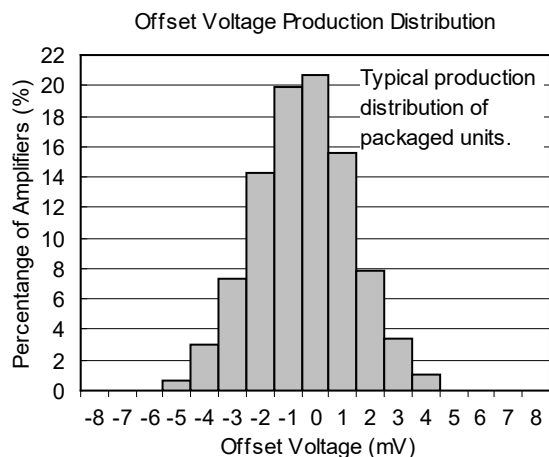
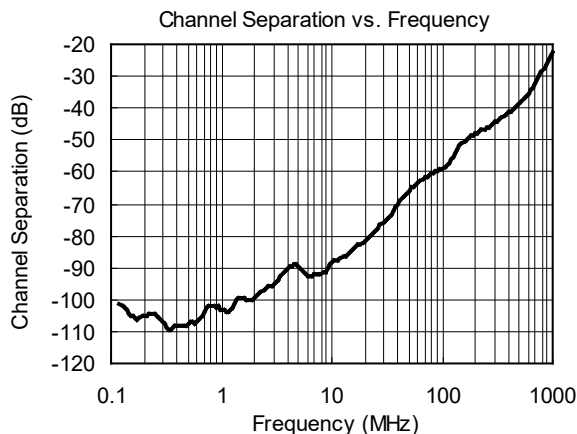
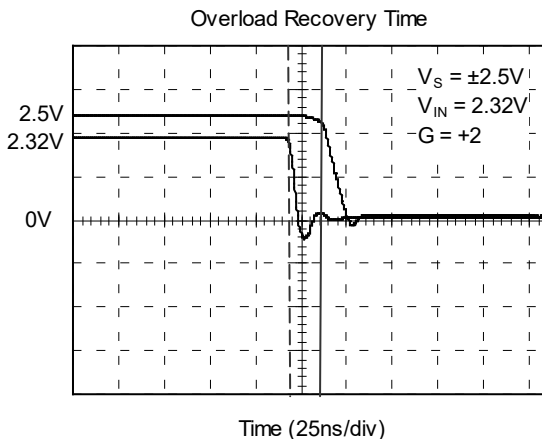

---

## REVISION HISTORY

NOTE: Page numbers for previous revisions may differ from page numbers in the current version.

<b>JANUARY 2013 – REV.B.3 to REV.B.4</b>	<b>Page</b>
Updated Package Outline Dimensions section .....	14~19
Added Tape and Reel Information section .....	20, 21
<hr/>	
<b>MAY 2011 – REV.B.2 to REV.B.3</b>	<b>Page</b>
Changed packages' name .....	All
<hr/>	
<b>JUNE 2010 – REV.B.1 to REV.B.2</b>	<b>Page</b>
Changed Electrical Characteristics section .....	3
Changed Package Outline Dimensions section .....	11~16
<hr/>	
<b>APRIL 2009 – REV.B to REV.B.1</b>	<b>Page</b>
Changed 16pin packages to 14pin packages.....	All
<hr/>	
<b>AUGUST 2008 – REV.A to REV.B</b>	<b>Page</b>
Changed Absolute Maximum Ratings section .....	3
<hr/>	
<b>Changes from Original (NOVEMBER 2006) to REV.A</b>	<b>Page</b>
Changed from product preview to production data.....	All

---

PACKAGE OUTLINE DIMENSIONS

SOT-23-5

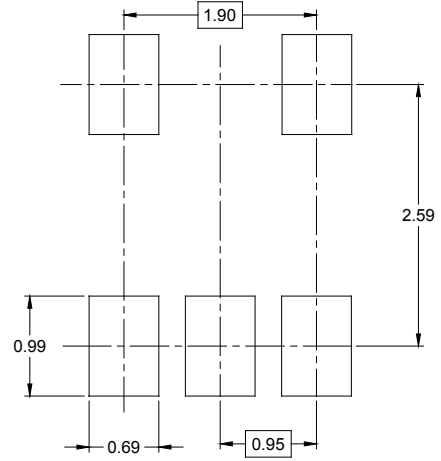
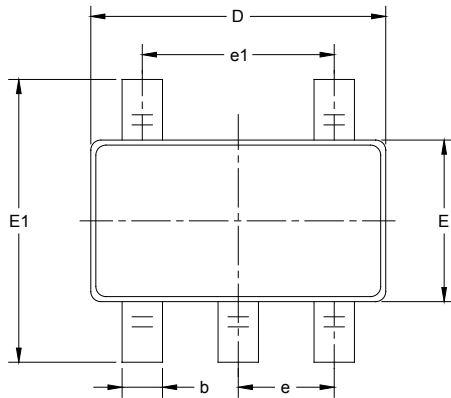

RECOMMENDED LAND PATTERN (Unit: mm)

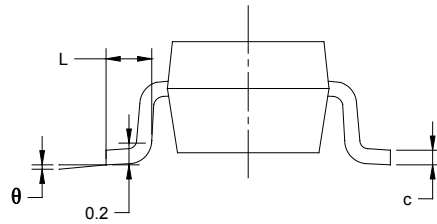
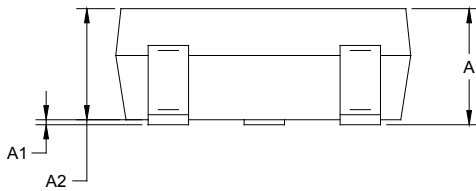

Symbol	Dimensions In Millimeters		Dimensions In Inches	
	MIN	MAX	MIN	MAX
A	1.050	1.250	0.041	0.049
A1	0.000	0.100	0.000	0.004
A2	1.050	1.150	0.041	0.045
b	0.300	0.500	0.012	0.020
c	0.100	0.200	0.004	0.008
D	2.820	3.020	0.111	0.119
E	1.500	1.700	0.059	0.067
E1	2.650	2.950	0.104	0.116
e	0.950 BSC		0.037 BSC	
e1	1.900 BSC		0.075 BSC	
L	0.300	0.600	0.012	0.024
$\theta$	0°	8°	0°	8°

PACKAGE OUTLINE DIMENSIONS

SOT-23-6

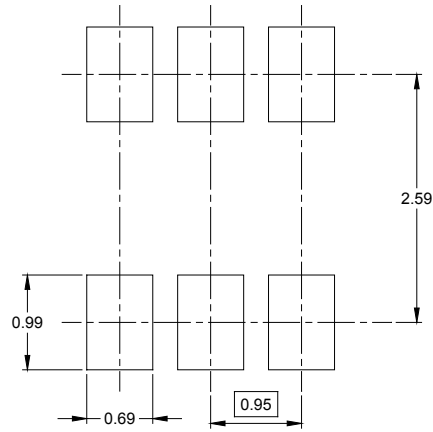
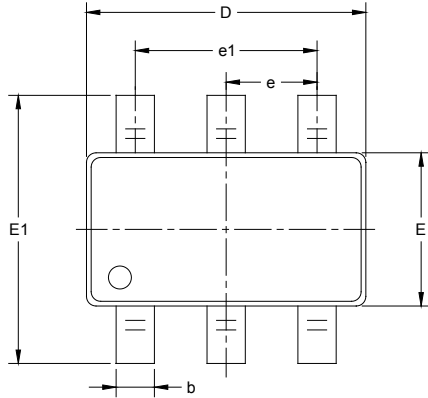

RECOMMENDED LAND PATTERN (Unit: mm)

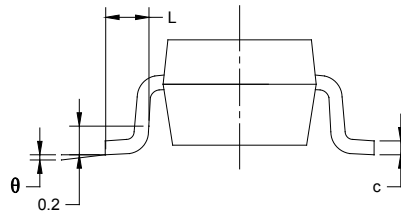
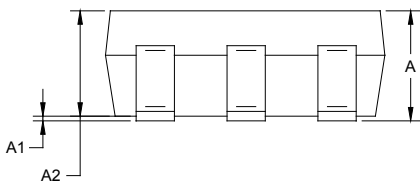

Symbol	Dimensions In Millimeters		Dimensions In Inches	
	MIN	MAX	MIN	MAX
A	1.050	1.250	0.041	0.049
A1	0.000	0.100	0.000	0.004
A2	1.050	1.150	0.041	0.045
b	0.300	0.500	0.012	0.020
c	0.100	0.200	0.004	0.008
D	2.820	3.020	0.111	0.119
E	1.500	1.700	0.059	0.067
E1	2.650	2.950	0.104	0.116
e	0.950 BSC		0.037 BSC	
e1	1.900 BSC		0.075 BSC	
L	0.300	0.600	0.012	0.024
θ	0°	8°	0°	8°

PACKAGE OUTLINE DIMENSIONS

SOIC-8

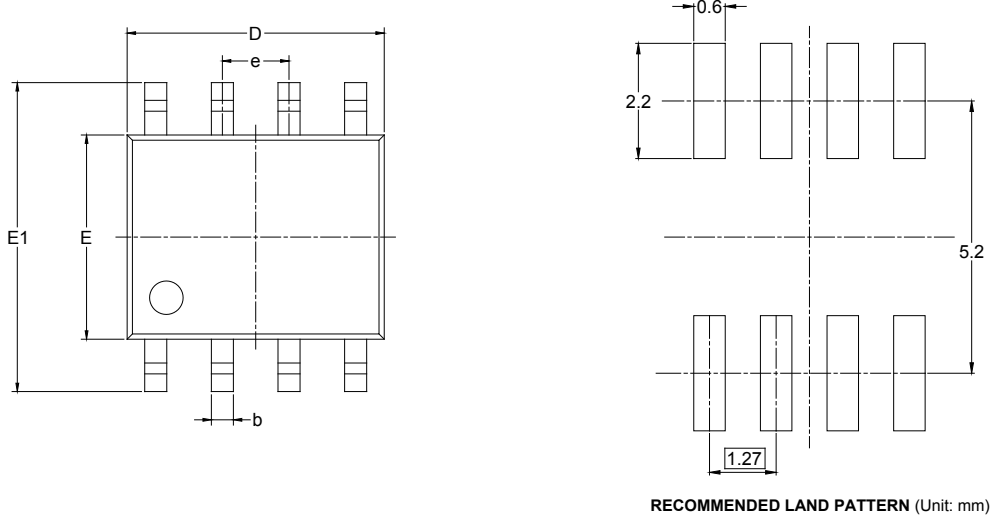

Symbol	Dimensions In Millimeters		Dimensions In Inches	
	MIN	MAX	MIN	MAX
A	1.350	1.750	0.053	0.069
A1	0.100	0.250	0.004	0.010
A2	1.350	1.550	0.053	0.061
b	0.330	0.510	0.013	0.020
c	0.170	0.250	0.006	0.010
D	4.700	5.100	0.185	0.200
E	3.800	4.000	0.150	0.157
E1	5.800	6.200	0.228	0.244
e	1.27 BSC		0.050 BSC	
L	0.400	1.270	0.016	0.050
$\theta$	0°	8°	0°	8°

PACKAGE OUTLINE DIMENSIONS

MSOP-8

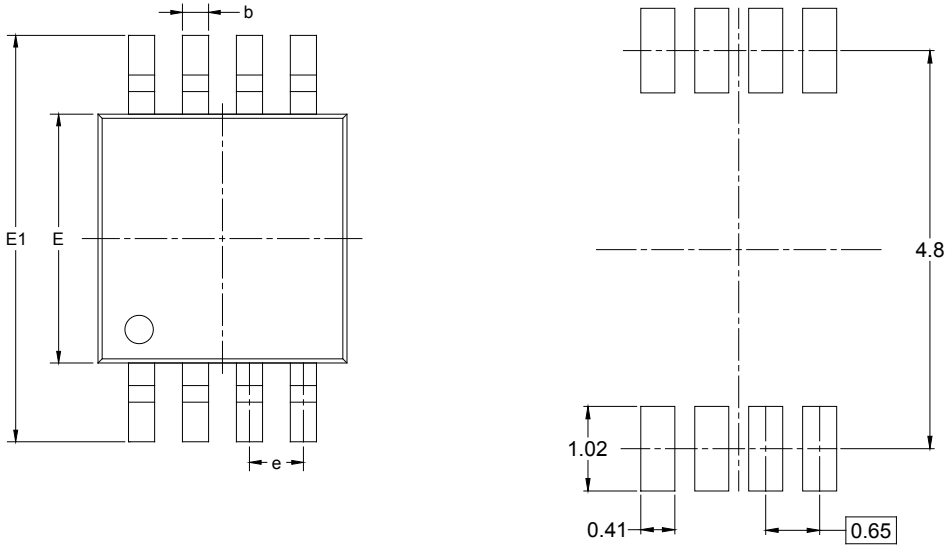

RECOMMENDED LAND PATTERN (Unit: mm)

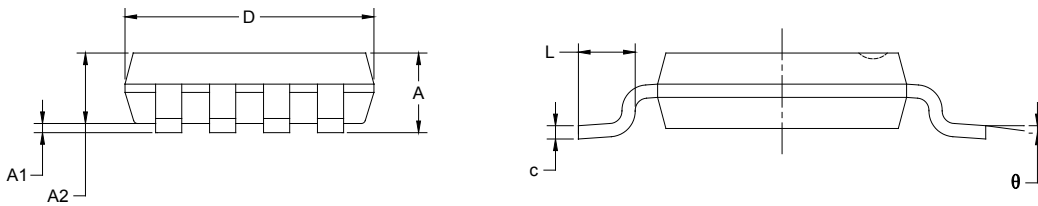

Symbol	Dimensions In Millimeters		Dimensions In Inches	
	MIN	MAX	MIN	MAX
A	0.820	1.100	0.032	0.043
A1	0.020	0.150	0.001	0.006
A2	0.750	0.950	0.030	0.037
b	0.250	0.380	0.010	0.015
c	0.090	0.230	0.004	0.009
D	2.900	3.100	0.114	0.122
E	2.900	3.100	0.114	0.122
E1	4.750	5.050	0.187	0.199
e	0.650 BSC		0.026 BSC	
L	0.400	0.800	0.016	0.031
θ	0°	6°	0°	6°

PACKAGE OUTLINE DIMENSIONS

SOIC-14

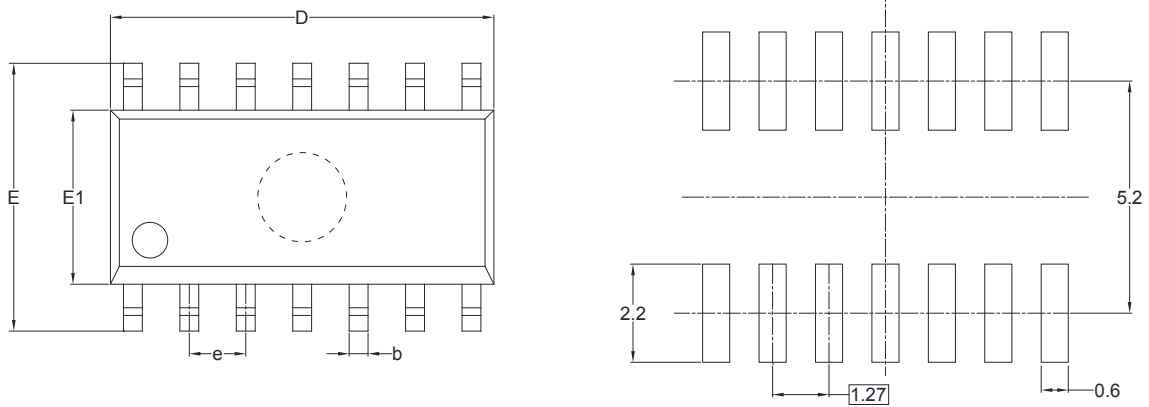

RECOMMENDED LAND PATTERN (Unit: mm)

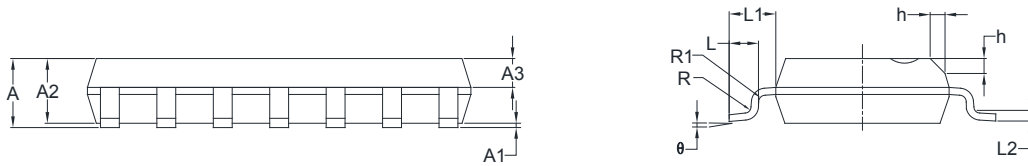

Symbol	Dimensions In Millimeters		Dimensions In Inches	
	MIN	MAX	MIN	MAX
A	1.35	1.75	0.053	0.069
A1	0.10	0.25	0.004	0.010
A2	1.25	1.65	0.049	0.065
A3	0.55	0.75	0.022	0.030
b	0.36	0.49	0.014	0.019
D	8.53	8.73	0.336	0.344
E	5.80	6.20	0.228	0.244
E1	3.80	4.00	0.150	0.157
e	1.27 BSC		0.050 BSC	
L	0.45	0.80	0.018	0.032
L1	1.04 REF		0.040 REF	
L2	0.25 BSC		0.01 BSC	
R	0.07		0.003	
R1	0.07		0.003	
h	0.30	0.50	0.012	0.020
θ	0°	8°	0°	8°



PACKAGE OUTLINE DIMENSIONS

TSSOP-14

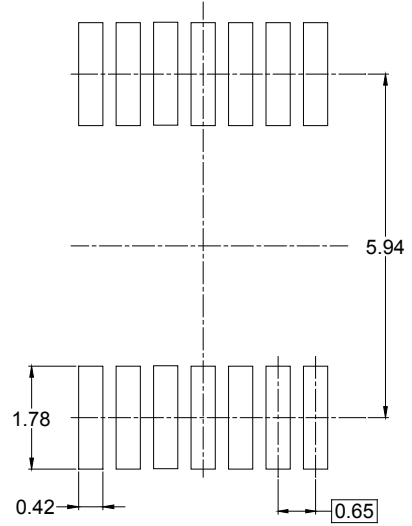
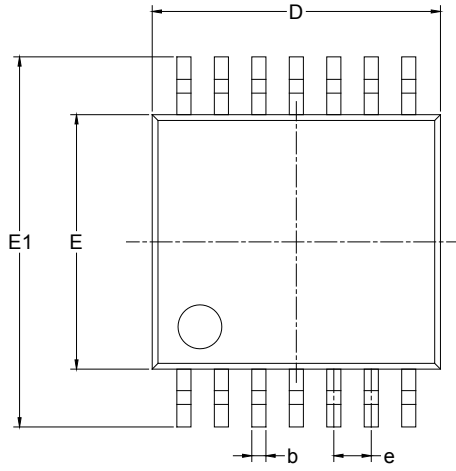

RECOMMENDED LAND PATTERN (Unit: mm)

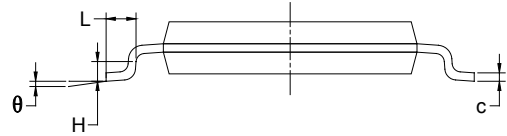
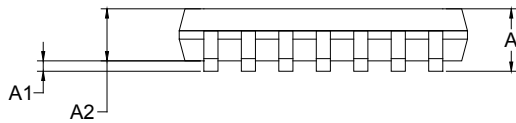

Symbol	Dimensions In Millimeters		Dimensions In Inches	
	MIN	MAX	MIN	MAX
A		1.200		0.047
A1	0.050	0.150	0.002	0.006
A2	0.800	1.050	0.031	0.041
b	0.190	0.300	0.007	0.012
c	0.090	0.200	0.004	0.008
D	4.860	5.100	0.191	0.201
E	4.300	4.500	0.169	0.177
E1	6.250	6.550	0.246	0.258
e	0.650 BSC		0.026 BSC	
L	0.500	0.700	0.02	0.028
H	0.25 TYP		0.01 TYP	
$\theta$	1°	7°	1°	7°

# PACKAGE INFORMATION

## TAPE AND REEL INFORMATION

### REEL DIMENSIONS

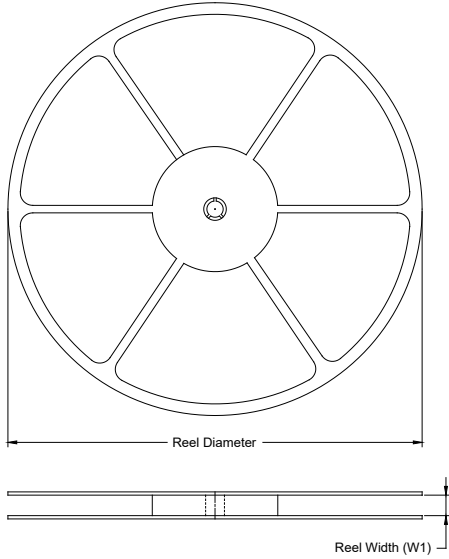

### TAPE DIMENSIONS

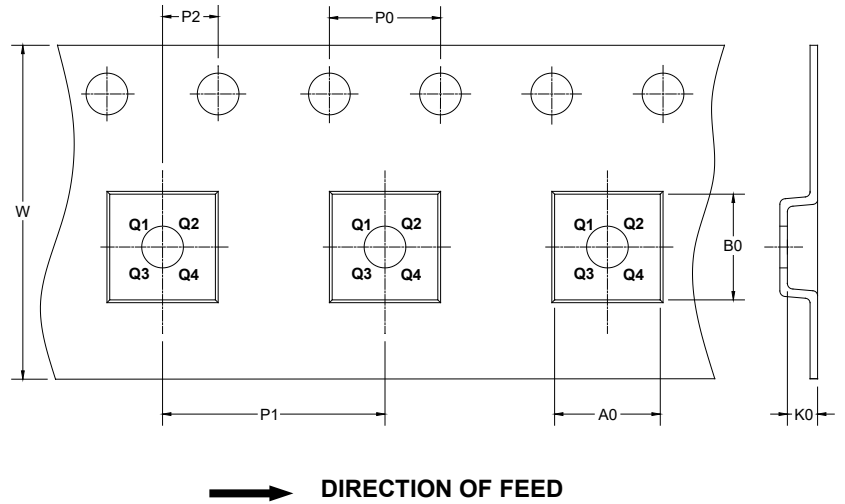

NOTE: The picture is only for reference. Please make the object as the standard.

### KEY PARAMETER LIST OF TAPE AND REEL

Package Type	Reel Diameter	Reel Width W1 (mm)	A0 (mm)	B0 (mm)	K0 (mm)	P0 (mm)	P1 (mm)	P2 (mm)	W (mm)	Pin1 Quadrant
SOT-23-5	7"	9.5	3.20	3.20	1.40	4.0	4.0	2.0	8.0	Q3
SOT-23-6	7"	9.5	3.17	3.23	1.37	4.0	4.0	2.0	8.0	Q3
SOIC-8	13"	12.4	6.40	5.40	2.10	4.0	8.0	2.0	12.0	Q1
MSOP-8	13"	12.4	5.20	3.30	1.50	4.0	8.0	2.0	12.0	Q1
SOIC-14	13"	16.4	6.60	9.30	2.10	4.0	8.0	2.0	16.0	Q1
TSSOP-14	13"	12.4	6.95	5.60	1.20	4.0	8.0	2.0	12.0	Q1

D00001

# PACKAGE INFORMATION

## CARTON BOX DIMENSIONS



NOTE: The picture is only for reference. Please make the object as the standard.

## KEY PARAMETER LIST OF CARTON BOX

Reel Type	Length (mm)	Width (mm)	Height (mm)	Pizza/Carton
7" (Option)	368	227	224	8
7"	442	410	224	18
13"	386	280	370	5

DD0002